

TESTING FOR THE VERIFICATION OF COMPLIANCE OF PV INVERTER WITH : VDE 0126-1-1 +VFR:2013 and VFR:2014: AUTOMATIC DISCONNECTION DEVICE BETWEEN A GENERATOR AND THE PUBLIC LOW-VOLTAGE GRID. 2013

Protocol PE.T-LE-62

Test Report Number : GZES200902788601

Trademark :



Tested Model..... : HYD 15KTL-3PH

Variant Models : HYD 5KTL-3PH, HYD 6KTL-3PH;
HYD 8KTL-3PH, HYD 10KTL-3PH, HYD 20KTL-3PH;

APPLICANT

Name : Shenzhen SOFAR SOLAR Co., Ltd.

Address : 401, Building 4, AnTongDa Industrial Park, District 68, XingDong
Community, XinAn Street, BaoAn District, Shenzhen, China.

TESTING LABORATORY

Name : SGS-CSTC Standards Technical Services Co., Ltd. Guangzhou
Branch

Address : 198 Kezhu Road, Science City, Economic & Technology
Development Area, Guangzhou, Guangdong, China

Conducted (tested) by : Hugo Zhang
(Project Engineer)

Reviewed & Approved by : Roger Hu
(Technical Reviewer)

Date of issue..... : 23/ 09 / 2020

Number of pages : 71



Important Note:

- This document is issued by the Company under its General Conditions of service accessible at http://www.sgs.com/terms_and_conditions.htm. Attention is drawn to the limitation of liability, indemnification and jurisdiction issues defined therein. Any holder of this document is advised that information contained hereon reflects the Company's findings at the time of its intervention only and within the limits of Client's instructions, if any. The Company's sole responsibility is to its Client and this document does not exonerate parties to a transaction from exercising all their rights and obligations under the transaction documents.
- Any unauthorized alteration, forgery or falsification of the content or appearance of this document is unlawful and offenders may be prosecuted to the fullest extent of the law.
- Unless otherwise stated the results shown in this test report refer only to the sample(s) tested as received. **Information of derived or extension models of the range as provided by the applicant, (if any), is included in this report only for informative purposes.** The Company SGS shall not be liable for any incorrect results arising from unclear, erroneous, incomplete, misleading or false information provided by Client. This document cannot be reproduced except in full, without prior approval of the Company.

Test Report Historical Revision:

Test Report Version	Date	Resume
GZES200902788601	23 / 09 / 2020	First issuance

INDEX

1	SCOPE	4
2	GENERAL INFORMATION.....	5
2.1	Testing Period and Climatic conditions	5
2.2	Equipment under Testing	5
2.3	Manufacturer and Factory information	9
2.4	Test Equipment List	10
2.5	Measurement Uncertainty	10
2.6	Test set up of the different standard	11
2.7	Definitions.....	12
3	RESUME OF TEST RESULTS.....	13
4	TEST RESULTS	14
4.1	Functional safety	14
4.2	Connection and reconnection conditions	15
4.3	Voltage monitoring	18
4.4	Frequency monitoring	28
4.5	DC current monitoring	35
4.6	Anti islanding protection	37
4.6.1	Test A	37
4.6.2	Test B	44
4.6.3	Test C	51
4.7	Marking.....	58
4.8	Residual Current	58
4.9	Table: Active power output feed-in at overfrequency	59
5	PICTURES.....	63
6	ELECTRICAL SCHEMES	71

1 SCOPE

SGS-CSTC Standards Technical Services Co., Ltd. Guangzhou Branch has been contract by Shenzhen SOFAR SOLAR Co., Ltd. to perform the testing according the VDE 0126-1-1:2013 +VFR:2013 and VFR:2014: Automatic disconnection device between a generator and the public low-voltage grid.

The following standard are covered with testing:

- Enedis-PRO-RES_10E:26/06/2020 Description et étude des protections de découplage pour le raccordement des Installations de Production raccordées au Réseau Public de Distribution

Copy of marking plate(representative):

SOFAR SOLAR Hybrid Inverter	
Model No:	HYD 15KTL-3PH
Max.DC Voltage	1000V
MPPT Voltage Range	180~960V
Max. Input Current	25/25A
Max. PV Isc	30/30A
Battery Type	Li-Ion
Battery Voltage Range	180~800V
Battery Max. Charging Current	25/25A
Battery Max. Discharging Current	25/25A
Nominal Grid/Back-up Voltage	3/N/PE, 380/400V
Nominal Grid/Back-up Frequency	50/60Hz
Max. Current Output to Grid	24A
Max. Power Output to Grid	16500VA
Max. Current from Grid	44A
Max. Power from Grid	30000VA
Back-up Max. Output Current	24A
Back-up Max. Output Power	16500VA
Power Factor	1 (adjustable +/- 0.8)
Operating Temperature Range	-30~+60°C
Ingress Protection	IP65
Protective Class	Class I
Inverter Topology	Non-isolated
Overvoltage Category	AC III, DC II
Manufacturer : Shenzhen SOFAR SOLAR Co., Ltd. Address : 401, Building 4, AnTongDa Industrial Park, District 68, XingDong Community, XinAn Street, BaoAn District, Shenzhen, China	
SAA VDE0126-1-1,VDE-AR-N4105 G98, G99, EN50438, AS4777, UTE C15-712-1	
	

Note:

1. The above markings are the minimum requirements required by the safety standard. For the final production samples, the additional markings which do not give rise to misunderstanding may be added.
2. Label is attached on the side surface of enclosure and visible after installation
3. Labels of other models are as the same with **HYD15KTL-3PH**'s except the parameters of rating.

Equipment under testing:

- HYD 15KTL-3PH;

The variants models are:

- HYD 5KTL-3PH;
- HYD 6KTL-3PH;
- HYD 8KTL-3PH;
- HYD 10KTL-3PH;
- HYD 20KTL-3PH;

Model	HYD 5KTL-3PH	HYD 6KTL-3PH	HYD 8KTL-3PH	HYD 10KTL-3PH	HYD 15KTL-3PH	HYD 20KTL-3PH
PV String Input Data						
Max. DC voltage	1000V					
MPPT voltage range	180V~960V					
Full power MPPT voltage range	250V~850V	320V~850V	360V~850V	220V~850V	350V~850V	450V~850V
Max. input current	12.5A/12.5A	12.5A/12.5A	12.5A/12.5A	25A/25A	25A/25A	25A/25A
Max. short current	15A/15A	15A/15A	15A/15A	30A/30A	30A/30A	30A/30A
Battery Input Data						
Battery voltage range	180V~800V					
Battery voltage range for full load	200V~800V	240V~800V	320V~800V	200V~800V	300V~800V	400V~800V
No. of battery input	1			2		
Nominal charging/discharging power	5000W	6000W	8000W	10000W	15000W	20000W
Max. charging/discharging current	25A	25A	25A	50A (25A/25A)	50A (25A/25A)	50A (25A/25A)
AC Output Data (On-grid)						
Nominal AC power	5000W	6000W	8000W	10000W	15000W	20000W
Max. AC power output to utility grid	5500VA	6600VA	8800VA	11000VA	16500VA	22000VA
Max. AC power from utility grid	10000VA	12000VA	16000VA	20000VA	30000VA	40000VA
Max. AC current output to utility grid	8A	10A	13A	16A	24A	32A
Rated AC current output to utility grid	7.2A	8.7A	11.6A	14.5A	21.7A	29A
Max. AC Current from utility grid	15A	17A	24A	29A	44A	58A

Nominal output voltage	3/N/PE, 230Vac					
Nominal output frequency	50Hz					
Output power factor	~1(0.8 leading to 0.8 lagging)					
AC Output Data (Back-up)						
Nominal output power	5000W	6000W	8000W	10000W	15000W	20000W
Max. output power	5500VA	6600VA	8800VA	11000VA	16500VA	22000VA
Rated. output current	7.2A	8.7A	11.6A	14.5A	21.7A	29A
Max. output current	8A	10A	13A	16A	24A	32A
Nominal output voltage	3/N/PE, 230Vac					
Nominal output frequency	50Hz					
Output power factor	~1(0.8 leading to 0.8 lagging)					
Operating temperature range	-30°C ~60°C					
Ingress protection	IP65					
Protective class	Class I					
Cooling method	Heat sink	Heat sink	Heat sink	Fan	Fan	Fan

The variants models have been included in this test report without tests because the following features don't change regarding to the tested model:

- Same connection system and hardware topology
- Same control algorithm.
- Output power within 1/√10 and 2 times of the rated output power or the EUT or Modular inverters.
- Same Firmware Version.

The results obtained apply only to the particular sample tested that is the subject of the present test report. The most unfavorable result values of the verifications and tests performed are contained herein. Throughout this report a point (comma) is used as the decimal separator.

2.3 Manufacturer and Factory information

Manufacturer Name..... : Shenzhen SOFAR SOLAR Co., Ltd.

Manufacturer Address..... : 401, Building 4, AnTongDa Industrial Park,
District 68, XingDong Community, XinAn Street,
BaoAn District, Shenzhen, China.

Factory Name..... : Dongguan SOFAR SOLAR Co., Ltd.

Factory Address : 1F - 6F, Building E, No. 1 JinQi Road, Bihu
Industrial Park, Wulian Village, Fenggang Town,
Dongguan,Guangdong. China.

2.4 Test Equipment List

From	No.	Equipment Name	Model No.	Equipment No.	Calibration Date	Equipment calibration due date
Sofar Solar	1	Digital oscilloscope	DSOX3014A	MY58491772	2020/01/14	2021/01/13
	2	Voltage probe	SI-9110	111152	2020/1/14	2021/1/13
	3	Voltage probe	SI-9110	152627	2020/01/14	2021/01/13
	4	Voltage probe	SI-9110	111134	2020/01/14	2021/01/13
	5	Power analyzer	PA5000H	C8202909082002 110001	2020/03/02	2021/03/01
	6	Current probe	CP1000A	C181000922	2020/01/14	2021/01/13
	7	Current probe	CP1000A	C181000925	2020/01/14	2021/01/13
	8	Current probe	CP1000A	C181000929	2020/01/14	2021/01/13
	9	Temperature & Humidity meter	TH101B	ZB-WSDJ-001	2020/01/14	2021/01/13
	10	Power analyzer	WT3000	91N610888	2020/01/14	2021/01/13
	11	Digital oscilloscope	DSOX3014A	MY58101647	2020/01/14	2021/01/13
	12	Power analyzer	PA5000	C8202909082002 110002	2020/03/02	2021/03/01
SGS	13	True RMS Multimeter	Fluke / 187	GZE012-8	2019/12/05	2020/12/04

2.5 Measurement Uncertainty

Associated uncertainties through measurements showed in this this report are the maximum allowable uncertainties.

Magnitude	Uncertainty
Voltage measurement	±1.5 %
Current measurement	±2.0 %
Frequency measurement	±0.2 %
Time measurement	±0.2 %
Power measurement	±2.5 %
Phase Angle	±1 °
Temperature	±3 °C

Note1: Measurements uncertainties showed in this table are maximum allowable uncertainties. The measurement uncertainties associated with other parameters measured during the tests are in the laboratory at disposal of the petitioner.

Note2: Where the standard requires lower uncertainties that those in this table. Most restrictive uncertainty has been considered.

2.6 Test set up of the different standard

Below is the simplified construction of the test set up.

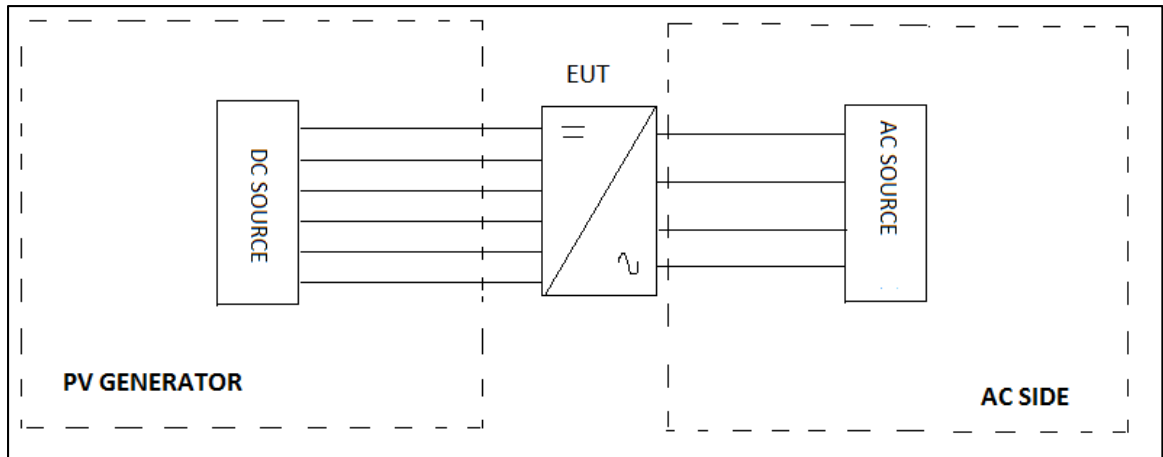

Different equipment has been used to take measures as it shows in chapter 2.3. Current and voltage clamps have been connected to the inverter input / output for all the tests. All the tests described in the following pages have used this specified test setup.

The test bench used includes:

EQUIPMENT	MARK / MODEL	RATED CHARACTERISTICS	OWNER / ID. CODE
AC source	Kwell / AFG-S-33800	Voltage: 0-600 V 750 kVA	Sofarsolar / EP-026
PV source	Kwell / TVS-630kW	Voltage: 0 - 1000 V 630 kW	Sofarsolar / EP-027
RLC load	Qunlin / ACLT3820H	68 kW, 68 kVAr	Sofarsolar / EP-029

2.7 Definitions

In	Nominal Current	P	Power
p.u	Per unit	I	Current
Pn	Nominal Power	M	Change for real power
Sn	Apparent Power	N	Change for reactive power
PGU	Power Generation Unit	F	Frequency
Pst	Short-term flicker strength	Q _f	Quality factor
Plt	Long-term flicker strength	NS	Network and System
C _{ψK}	Flicker coefficient for continuous operation	Un	Nominal Voltage
S _r	Apparent Power Rated	PWHD	Partial weight harmonic distortion
S _k	Short-circuit Apparent Power	THD	Total harmonic distortion
K _{imax}	Maximum switching current factor	Z _{test}	Test circuit impedance at which the emission test
Z _{ref}	The reference impedance	EUT	Equipment under test

3 RESUME OF TEST RESULTS

INTERPRETATION KEYS

- Test object does meet the requirement **P** Pass
- Test object does not meet the requirement **F** Fails
- Test case does not apply to the test object **N/A** Not applicable
- To make a reference to a table or an annex..... See additional sheet
- To indicate that the test has not been realized..... **N/R** Not realized

<u>CHAPTER OF THE STANDARD, DESCRIPTION AND VERIFICATION</u>			
4	Requirements		
4.1	Functional safety		P
4.2	Reconnection		P
4.3.1	Voltage monitoring -20%		P
4.3.2	Voltage monitoring +10%		P
4.3.3	Voltage monitoring +15%		P
4.4.1	Frequency monitoring: 51.5Hz		P
4.4.2	Frequency monitoring: 47.5Hz		P
4.5	DC current monitoring		P
4.6	Anti-Islanding Protection		P
4.7	Marking		P
4.8	Residual Current		P
4.9	Table: Active poewr output feed-in at overfrequency		P

4 TEST RESULTS

4.1 FUNCTIONAL SAFETY

The security as defined in 4.3 to 4.8 of the standard must turn in an error state and display this error condition.

Testing of the single-fault tolerance and fault detection with subsequent disconnection is carried out by fault simulation, if necessary with additional fault tests.

It must be checked that a single fault does not lead to loss of the safety function.

The results are offered in the table below:

Based on an analysis of the products circuits, capacitors, diodes, solid –state devices and similar component were subjected to shorting or opening while the product was energized at rated voltage and under load (if grid connected it shall be tied to a simulated grid). Evidence of malfunction as specified above shall be noted and recorder.

In addition the utility – interactive inverter was monitored for backfeed current that flows from the simulated utility source into the photovoltaic array as a result of a faulted components. This was done by monitoring the dc current to the dc supply input with the dc source off and the simulated circuit operating.

The compliances with these requirements are stated in section 4.4 on pages 58 to 62 of the following test report:

-IEC 62109-1:2010: Test Report n° BL-DG2060127-B01 on 02 July.,2020 which issued by Shenzhen BALUN Technology Co., Ltd.

4.2 CONNECTION AND RECONNECTION CONDITIONS

The power generation system shall be connected to the network only if both voltage and frequency are within the tolerance range according to article 4.2. It is shown that the active power don't exceed the gradient of 10 % of the active power per minute (green line).

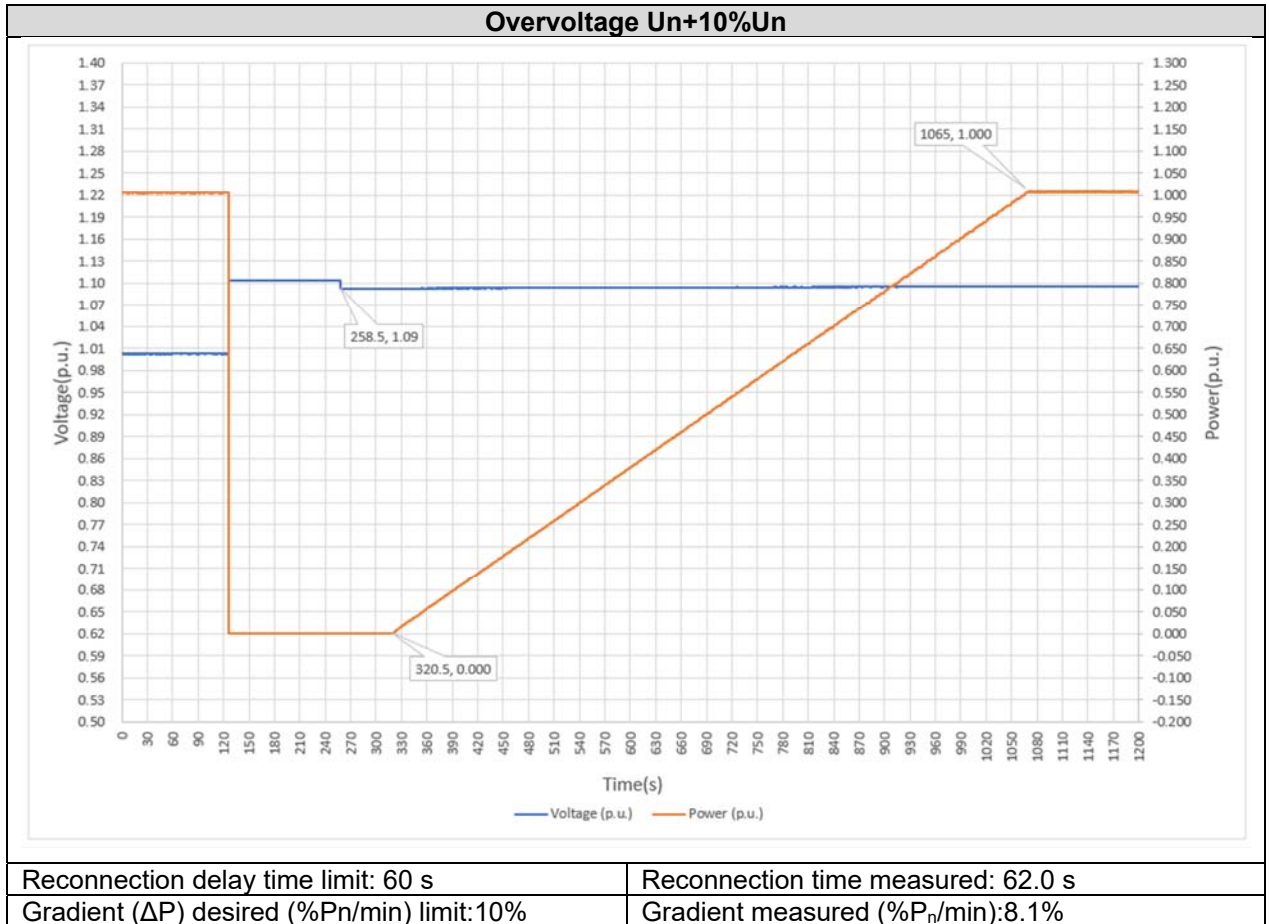

Undervoltage Un-15%Un

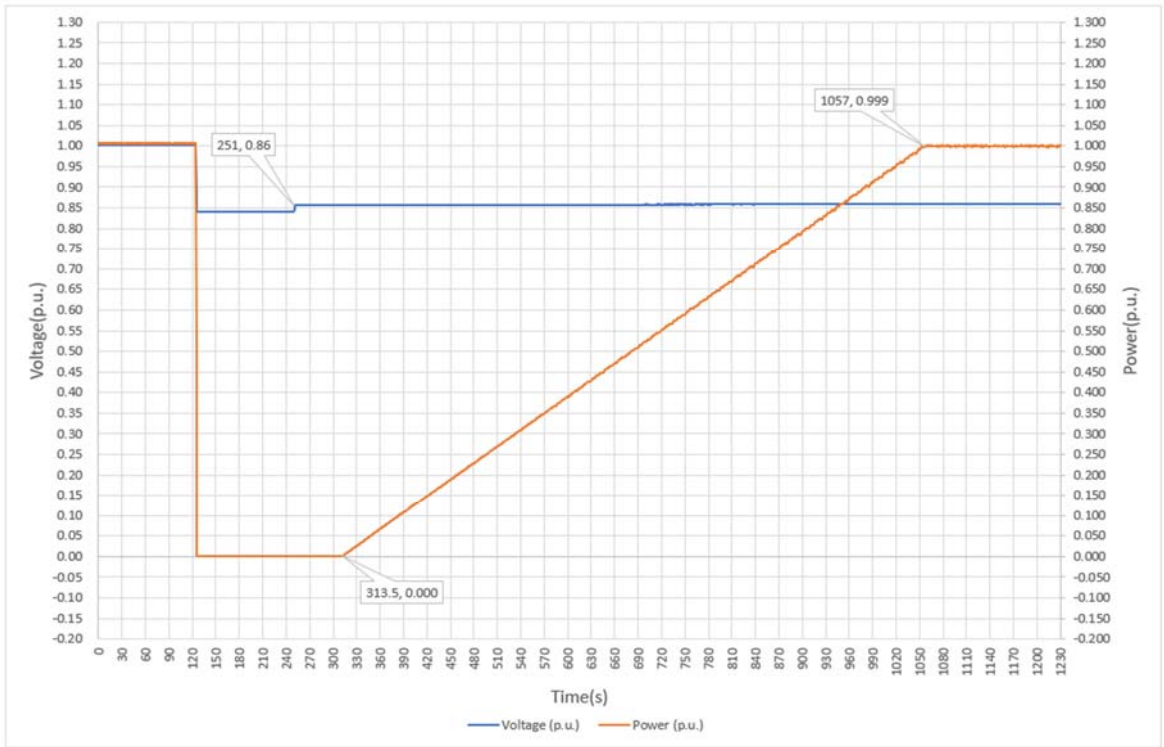

Reconnection delay time limit: 60 s
 Gradient (ΔP) desired (%P_n/min) limit: 10%

Reconnection time measured: 62.5 s
 Gradient measured (%P_n/min): 8.1%

Overfrequency 50.05 Hz

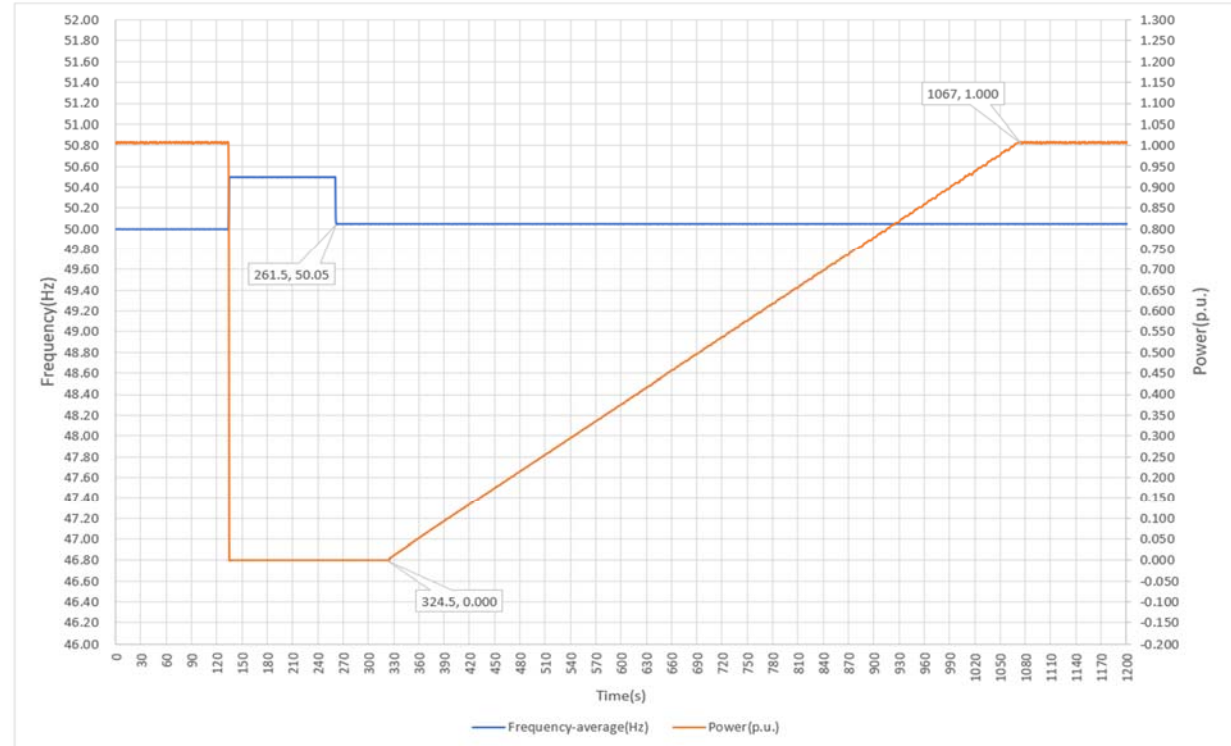

Reconnection delay time limit: 60 s
 Gradient (ΔP) desired (%P_n/min) limit: 10%

Reconnection time measured: 63.0 s
 Gradient measured (%P_n/min): 8.1%

Underfrequency 47.5 Hz

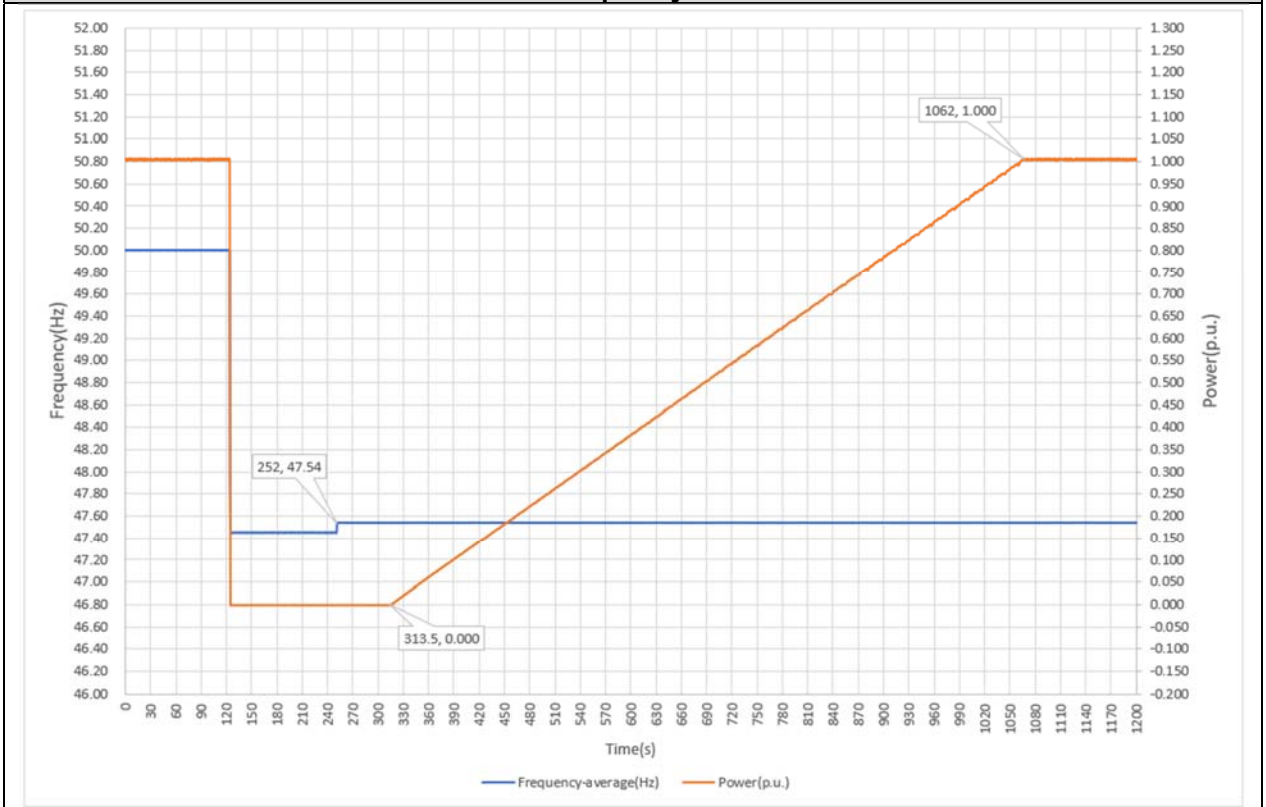

Reconnection delay time limit: 60 s	Reconnection time measured: 61.5 s
Gradient (ΔP) desired (%P _n /min) limit: 10%	Gradient measured (%P _n /min): 8.0%

4.3 VOLTAGE MONITORING

According to article 4.3 the NS protection should disconnect the power generation system from the net in the event of inadmissible voltage values. This point of the standard redirect to the point 6.5 of the VDE AR-N 4105:2011.

- a) For measurement of the phase to phase voltages the phase angle must be turned so that one phase to phase voltage reaches the limit value, whereby the phase to neutral voltages for testing the overvoltage are set to 110 % U_n and for undervoltage to 90 % U_n .
- b) For the measurement of the phase to neutral voltage, one phase to neutral voltage should be changed, whereby both other phase to neutral voltages are maintained at the nominal voltage. This test must be carried out separately for each phase.

To measure the response time, a voltage changes of:

- Nominal voltage to 118 % U_n for overvoltage and
- Nominal voltage to 77 % U_n for undervoltage

is carried out.

All tests for verification of the disconnection values and times must be carried out three times.

The results are offered in the table below:

Disconnection time measured					
Protective function	Voltage changes	Disconnection time limits	Test 1	Test 2	Test 3
Rise-in-voltage protection ($U >>$)	100% U_n to 118% U_n	< 200 ms	147 ms	153 ms	149 ms
Voltage drop protection ($U <$)	100% U_n to 77% U_n	< 200 ms	161 ms	145 ms	151 ms

In the picture below are offered waveforms and graphically the results of the test.

Nominal voltage to 118 % Un for overvoltage - Test 1

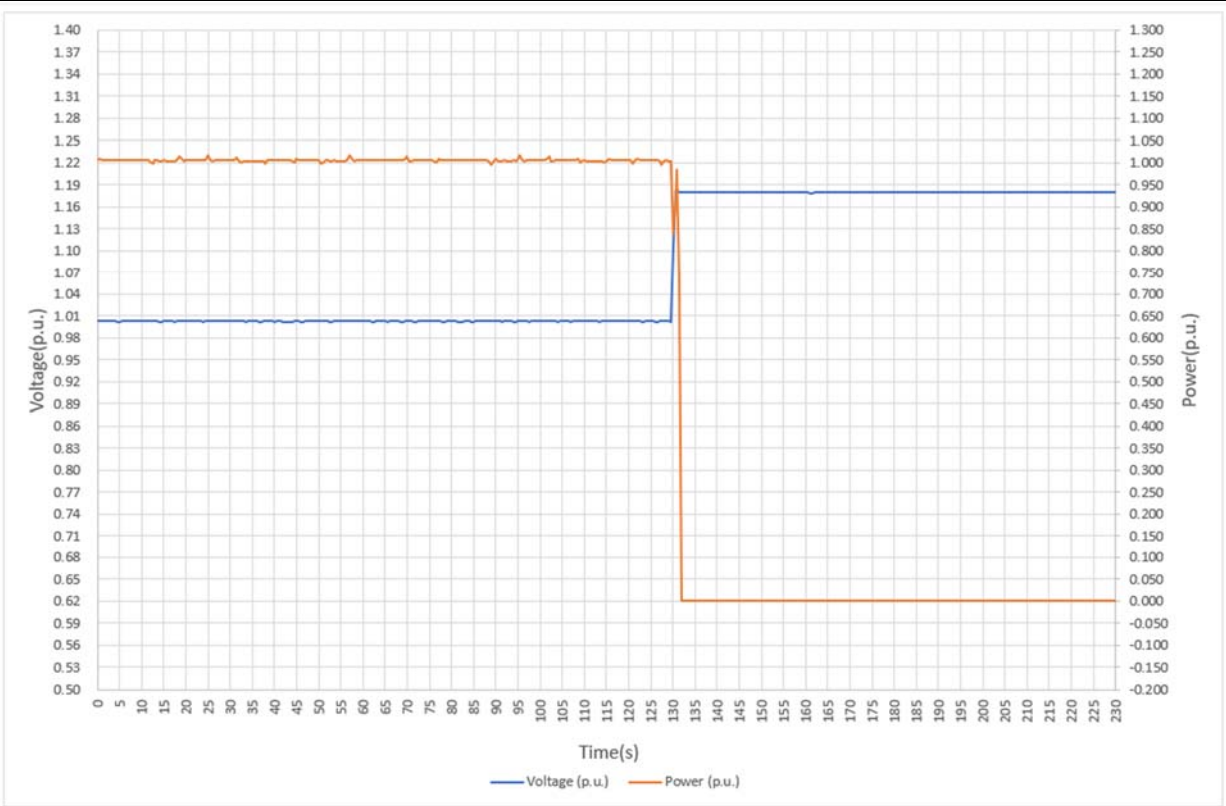

DSO-X 3014A, MY58101647: Tue Jul 28 09:43:01 2020

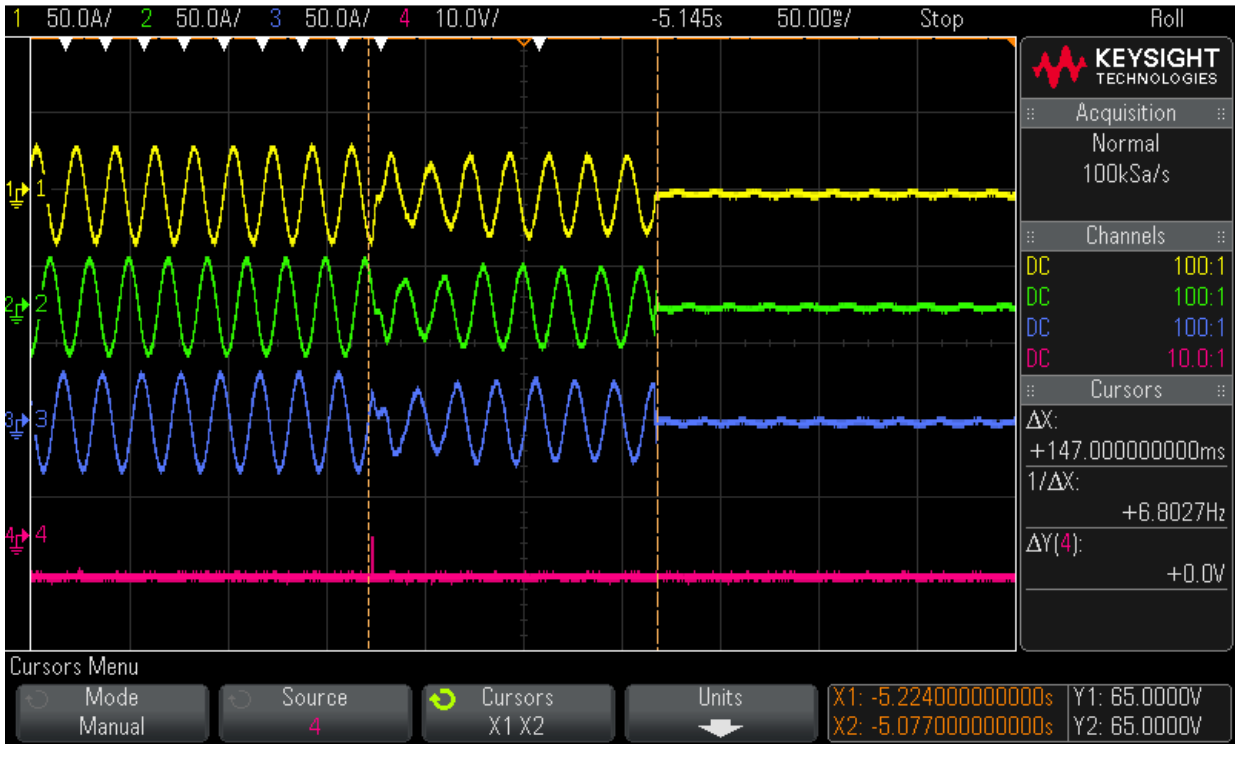

Nominal voltage to 118 % Un for overvoltage - Test 2

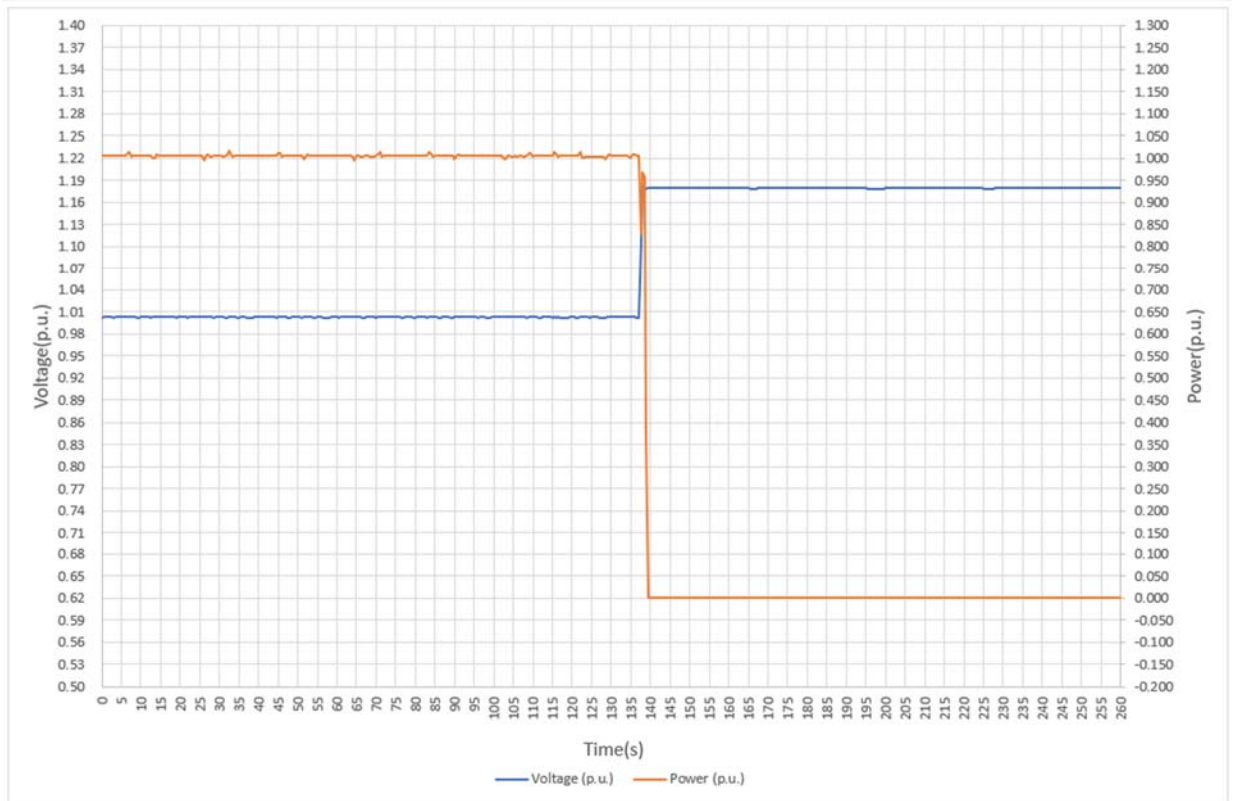

DSO-X 3014A, MY58101647: Tue Jul 28 09:45:06 2020

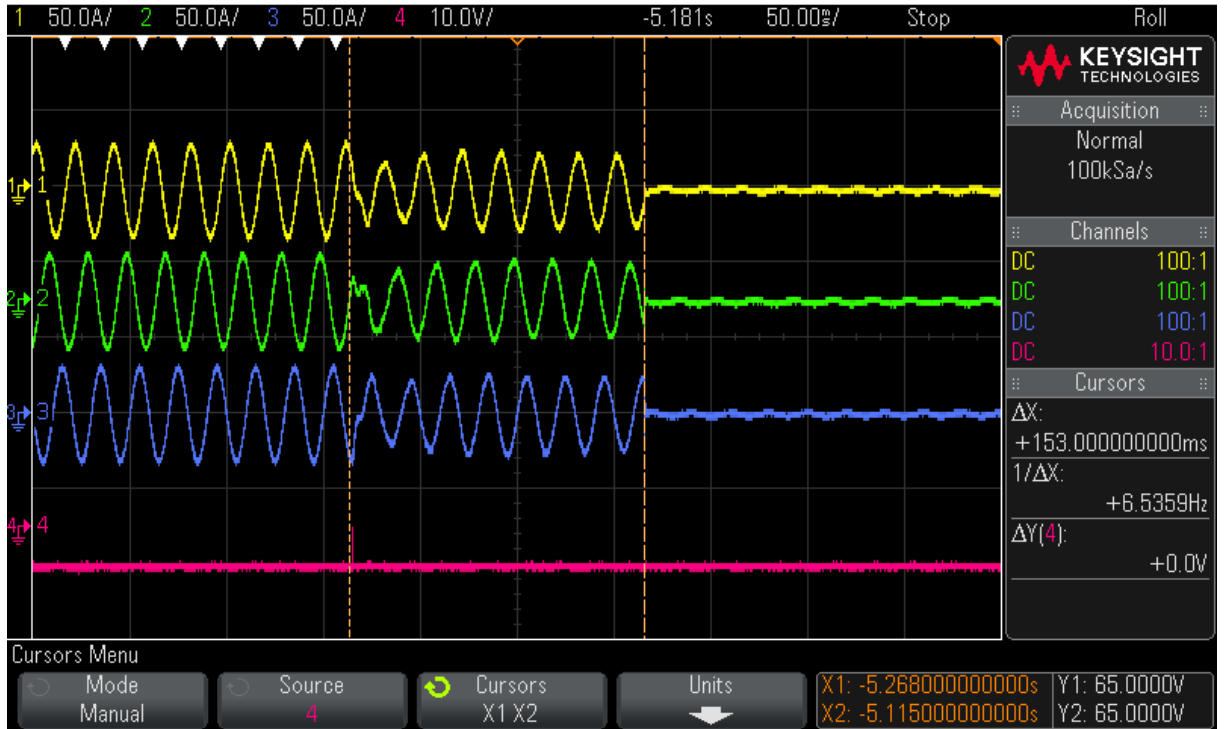

Nominal voltage to 118 % Un for overvoltage - Test 3

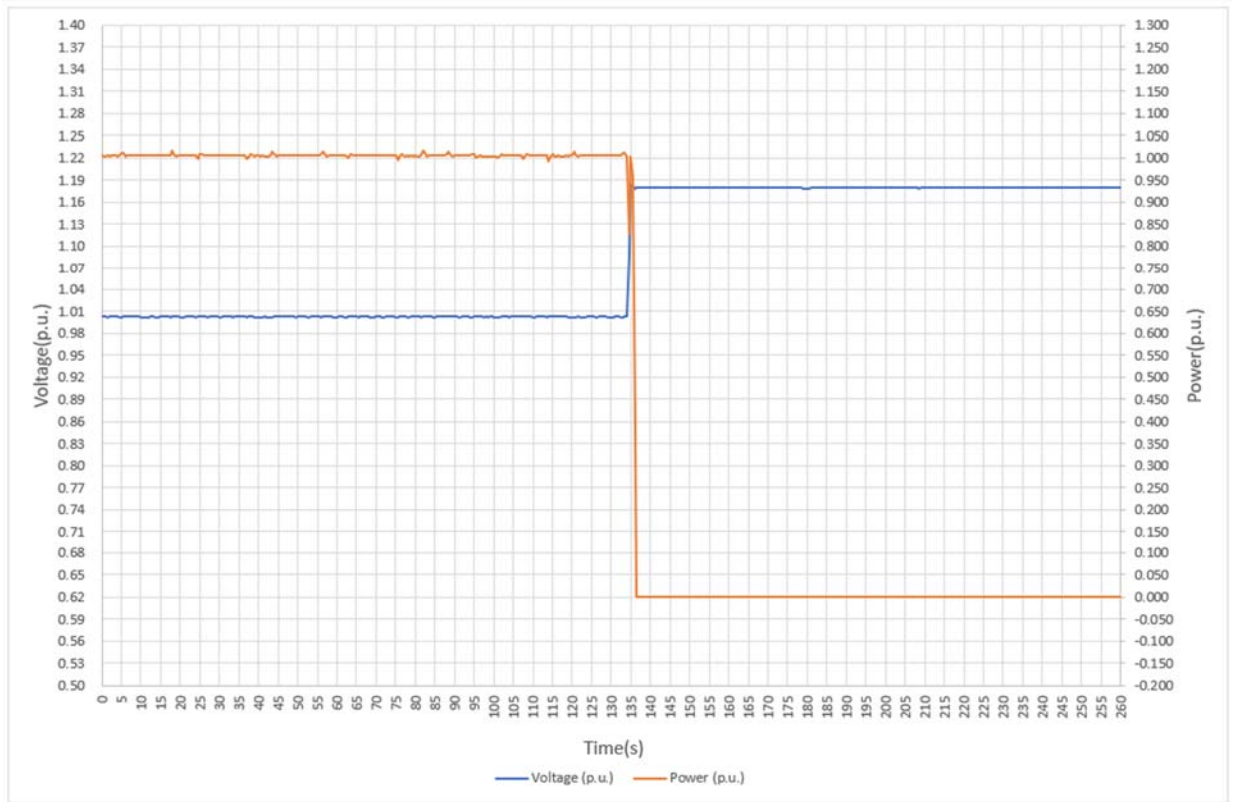

DSO-X 3014A, MY58101647: Tue Jul 28 09:46:23 2020

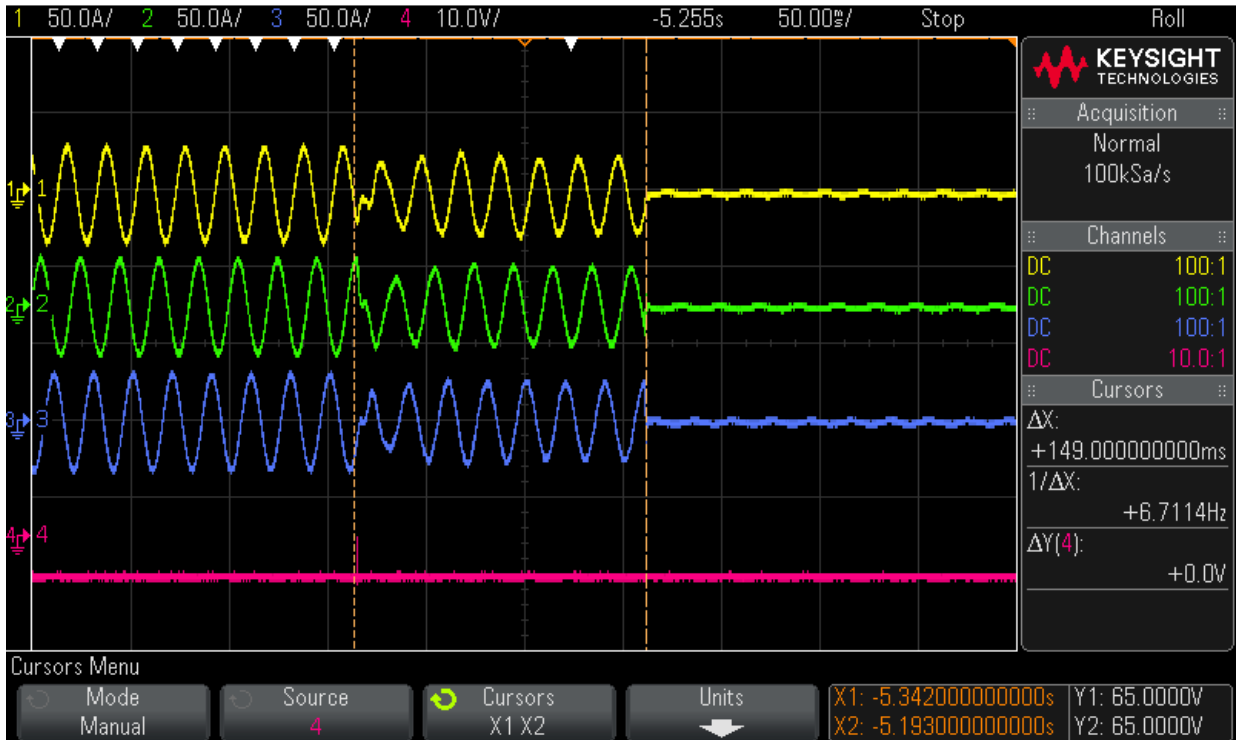

Nominal voltage to 77 % Un for undervoltage - Test 1

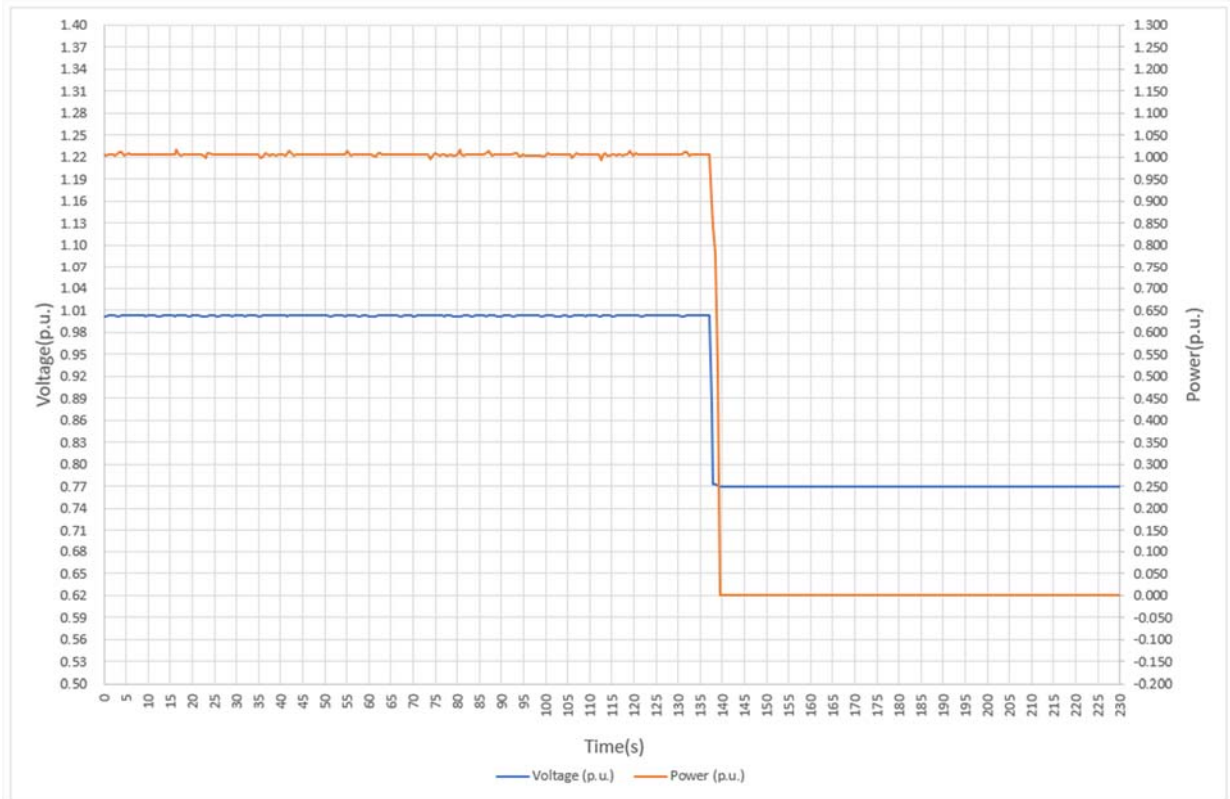

DSO-X 3014A, MY58101647: Tue Jul 28 09:49:46 2020

1 50.0A/ 2 50.0A/ 3 50.0A/ 4 10.0V/ -5.069s 50.00%/ Stop Roll

The oscilloscope screen shows four channels of waveforms. Channel 1 (yellow) is a high-frequency sine wave. Channel 2 (green) is a lower-frequency sine wave. Channel 3 (blue) is a sine wave with a period similar to channel 2. Channel 4 (magenta) is a flat line at 0.0V. The control panel on the right shows the following settings:

- Acquisition: Normal, 100kSa/s
- Channels: DC 100:1, DC 100:1, DC 100:1, DC 10.0:1
- Cursors: ΔX : +161.000000000ms, $1/\Delta X$: +6.2112Hz, $\Delta Y(4)$: +0.0V

Buttons at the bottom include 'Save to file = scope_9', 'Save', 'Recall', 'Default/Erase', and 'Press to Save'.

Nominal voltage to 77 % Un for undervoltage - Test 2

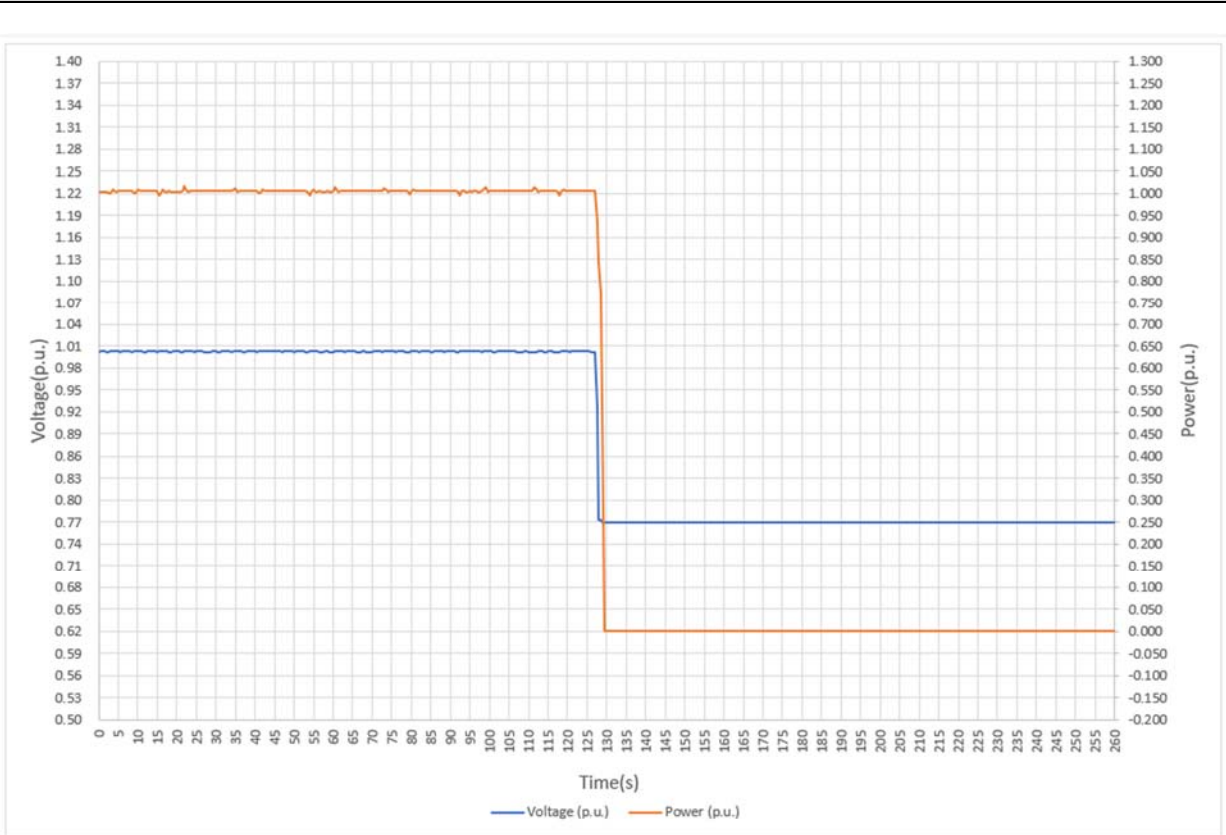

DSO-X 3014A, MY58101647: Tue Jul 28 09:53:21 2020

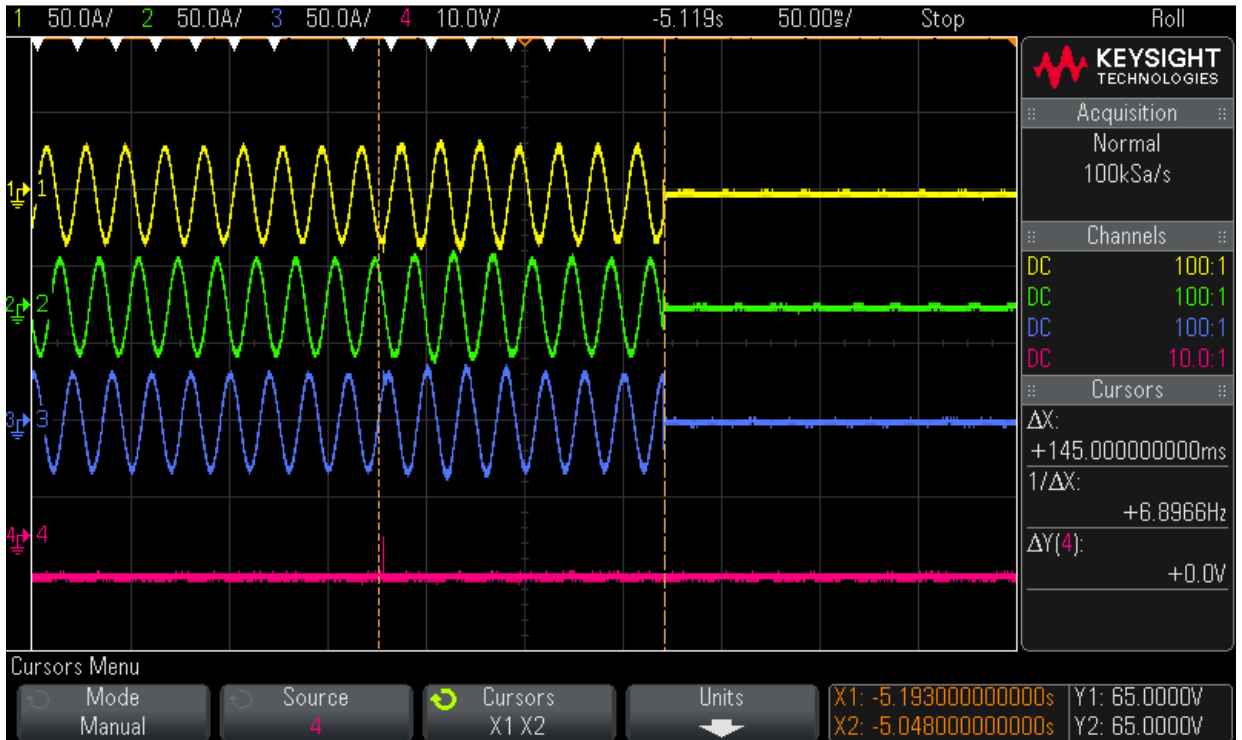

Nominal voltage to 77 % Un for undervoltage - Test 3

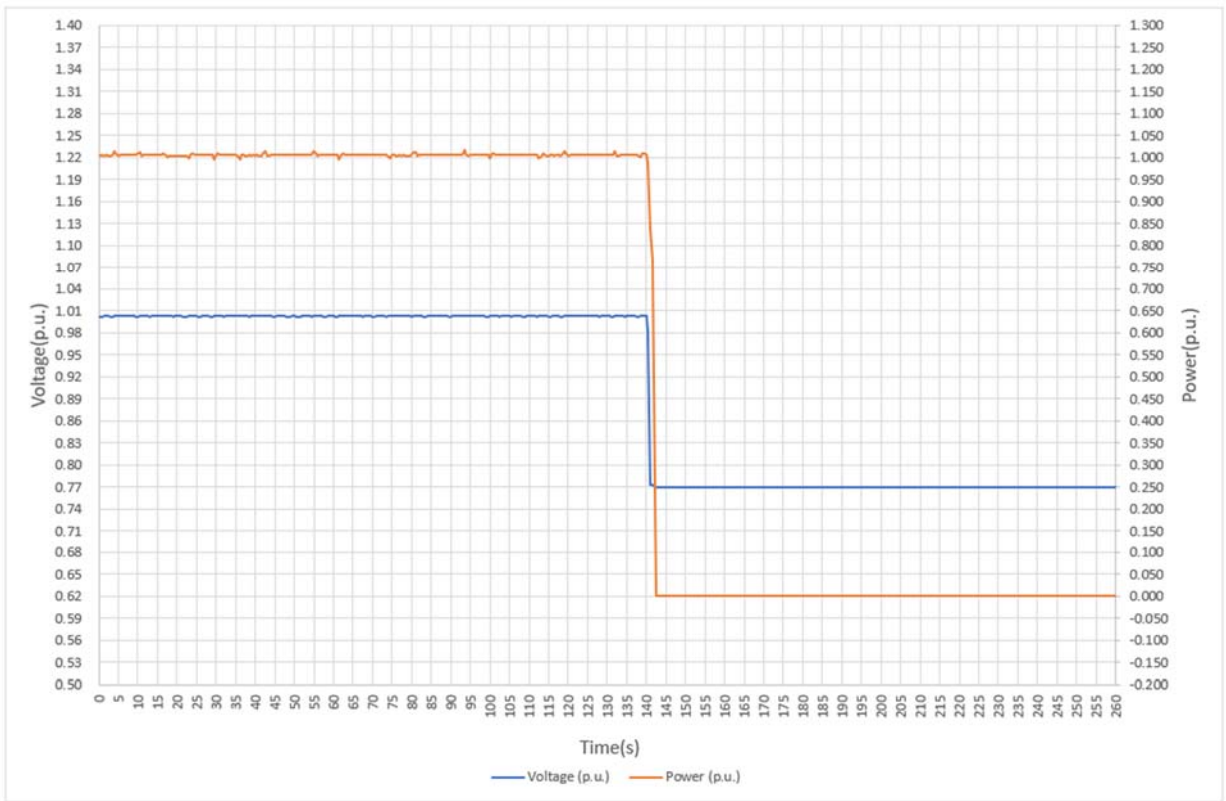

DSO-X 3014A, MY58101647: Tue Jul 28 09:56:56 2020

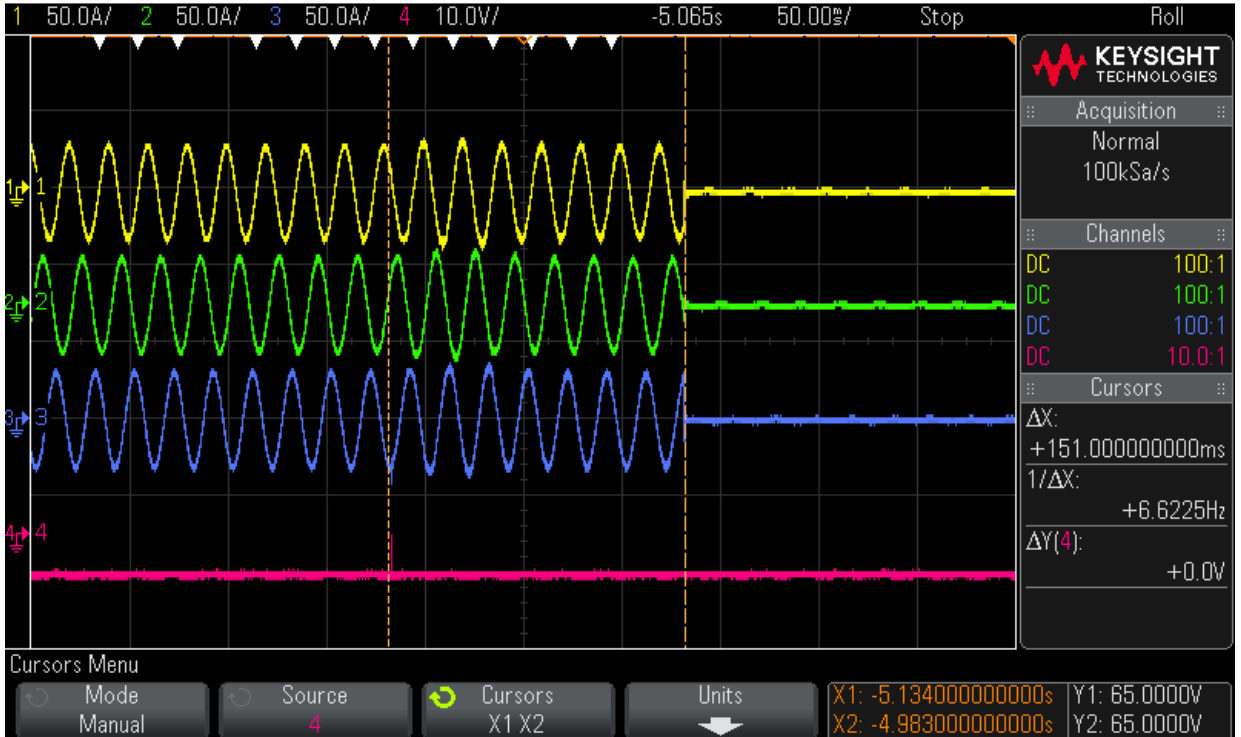

The rise-in voltage protection $U >$ test is carried out as follows:

- a) The voltage is set to 100 % U_n and maintained for 600 s. The voltage is then set to 112 % U_n . Disconnection must be effected within 600 seconds.

NOTE This test serves to verify the measuring accuracy and the maximum set time.

- b) The voltage is set for 600 s to U_n , then for 600 s to 108 % U_n . Disconnection should not occur.

NOTE This test serves to verify the measuring accuracy.

- c) The voltage is set to 106 % U_n and maintained for 600 s. The voltage is then set to 114 % U_n . Disconnection must be effected within 300 seconds.

In the pictures below are offered graphically the results of the test.

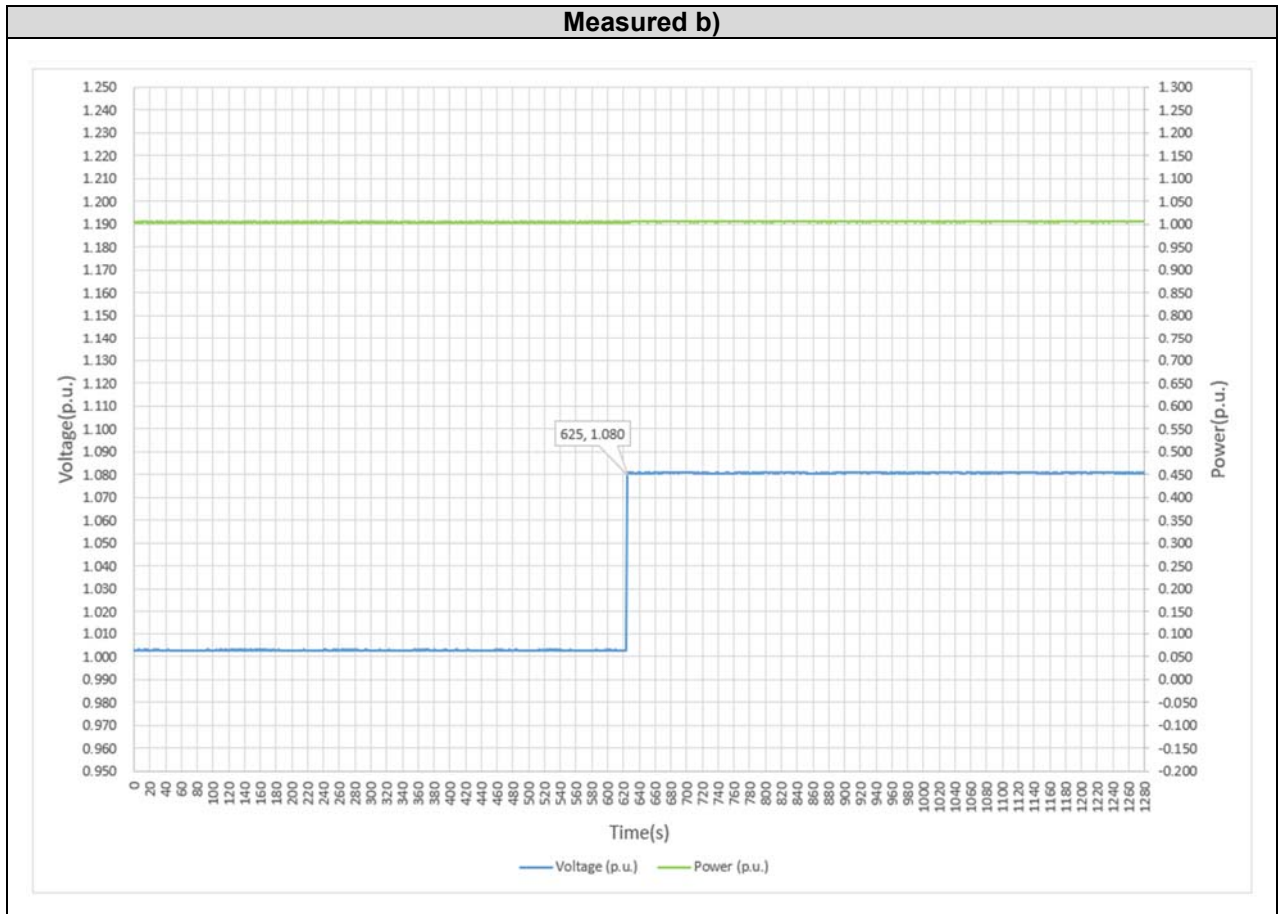
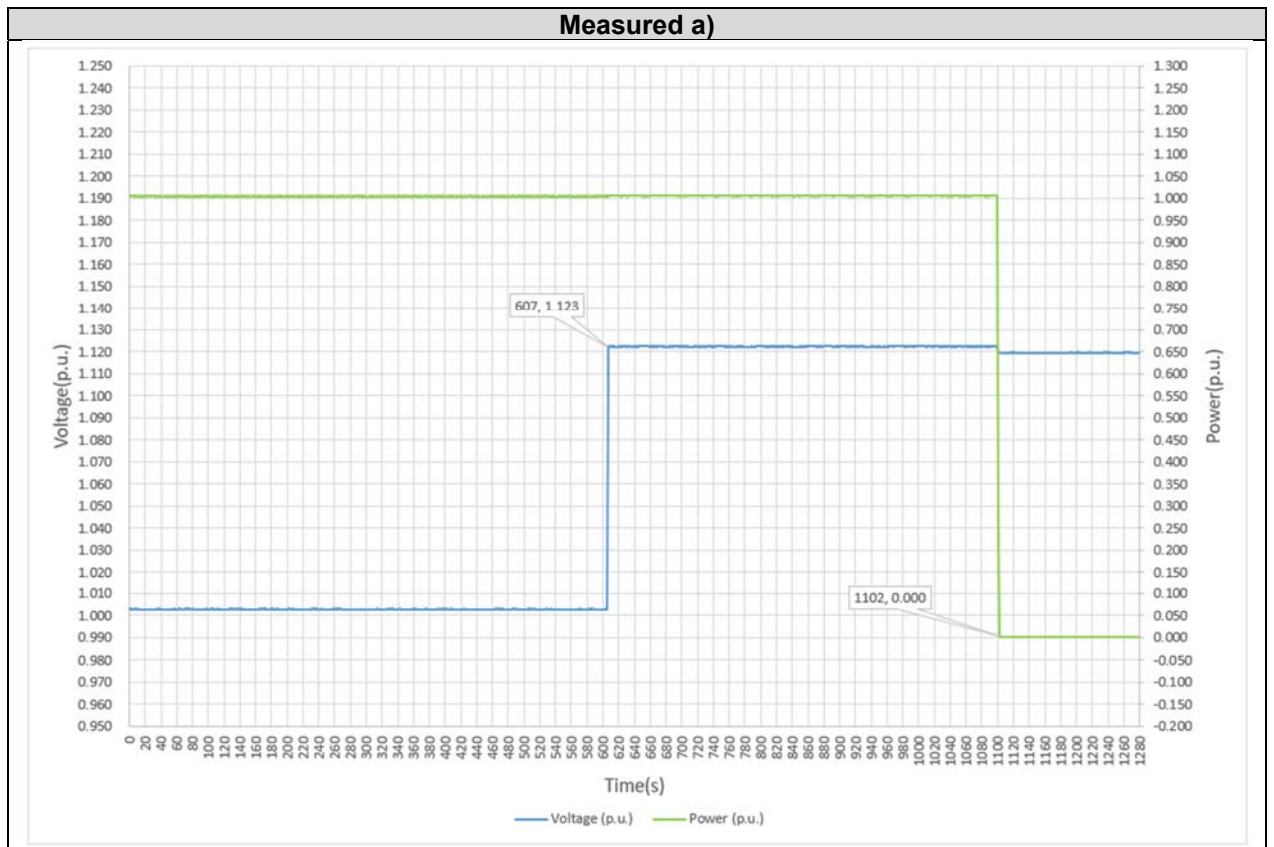

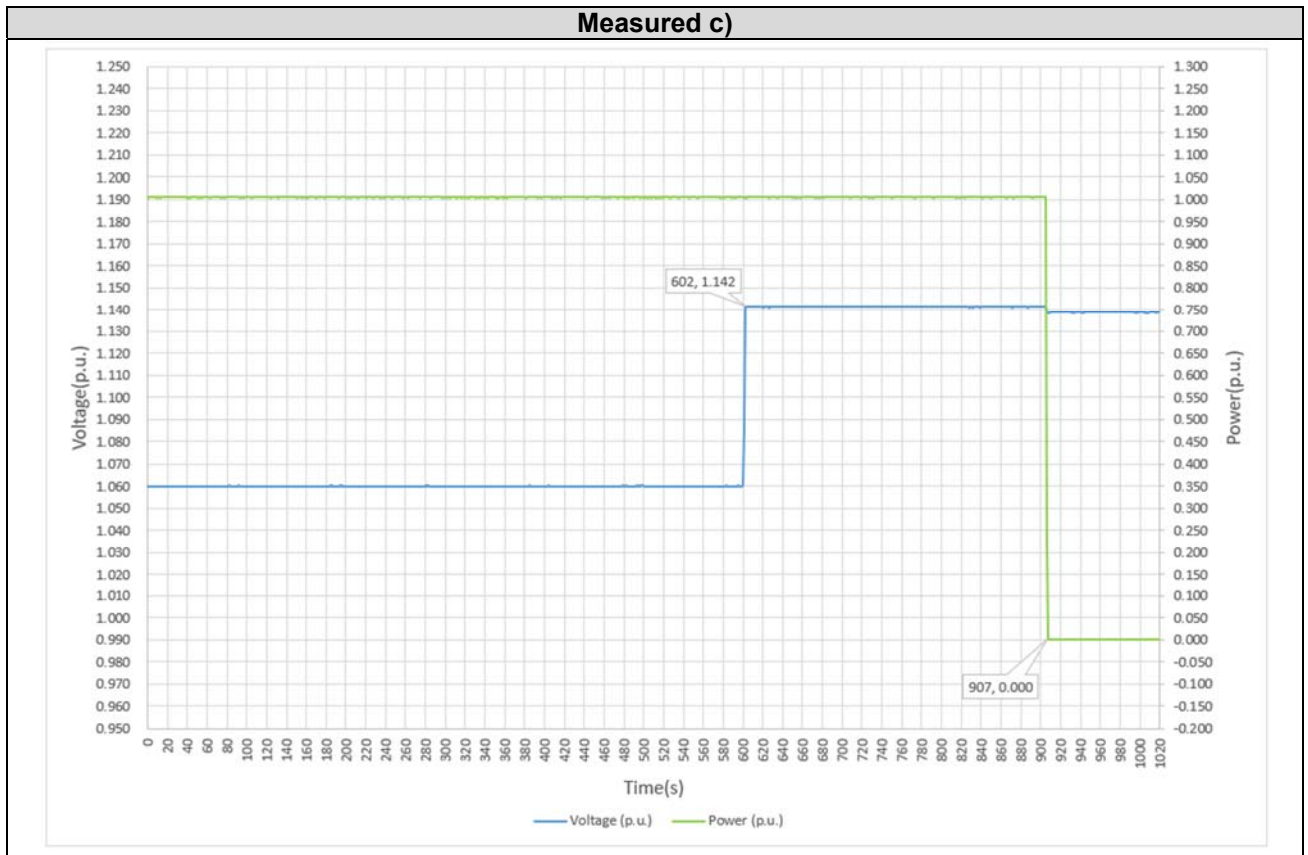

4.4 FREQUENCY MONITORING

According to article 4.4 the NS protection should disconnect the power generation system from the net in the event of inadmissible frequency values.

The requirement from Enedis-PRO-RES_10E:26/06/2020 have been consider in this section.

Disconnection time measured					
Protective function	Frequency changes	Disconnection time limits	Test 1	Test 2	Test 3
Frequency increase protection ($f >$)	50.00 Hz to 51.48 Hz to 51.55 Hz	< 200 ms	181 ms	168ms	176 ms
Frequency decrease protection ($f <$)	50.00Hz to 47.53Hz to 47.45 Hz	< 200 ms	164 ms	164 ms	179ms

In the picture below are offered waveforms and graphically the results of the test.

Overfrequency 51.5 Hz- Test 1

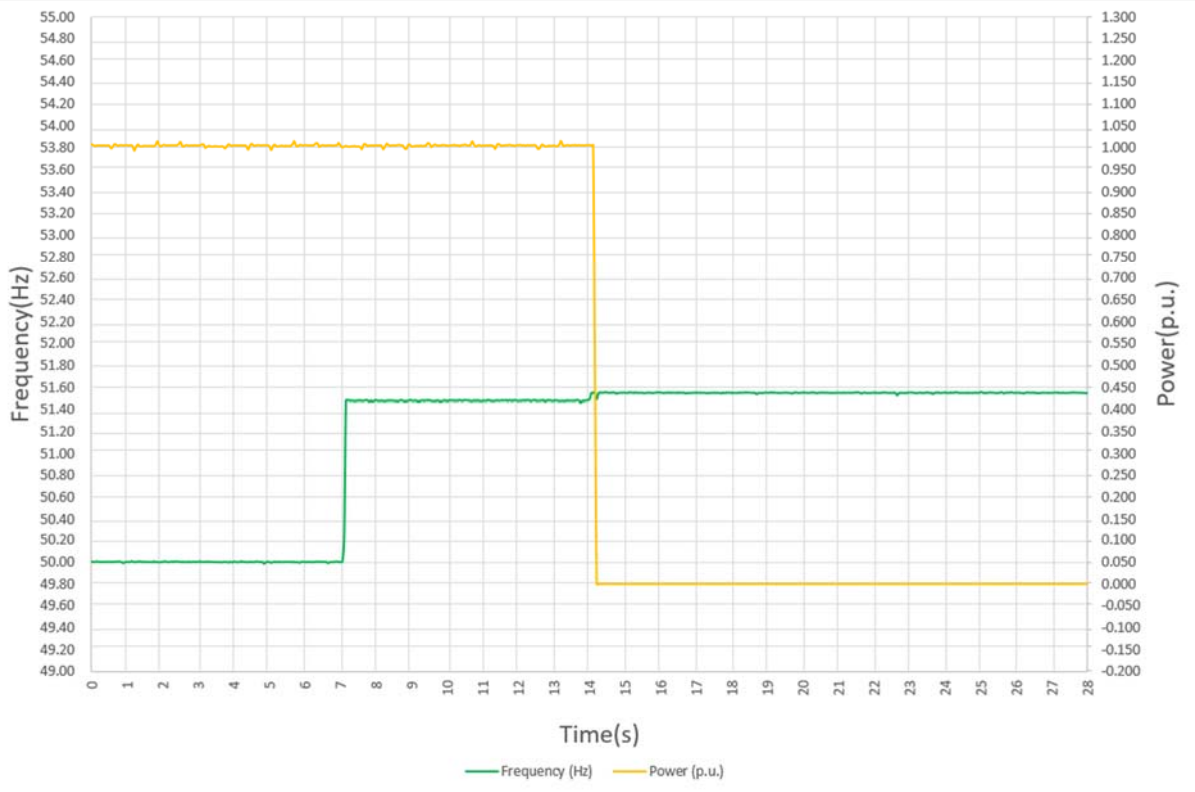

DSO-X 3014A, MY58101647: Tue Jul 28 10:06:58 2020

1 50.0A/ 2 50.0A/ 3 50.0A/ 4 10.0V/ -6.040s 50.00%/ Stop Roll

KEYSIGHT TECHNOLOGIES

Acquisition: Normal, 100kSa/s

Channels: DC 100:1, DC 100:1, DC 100:1, DC 10.0:1

Cursors: ΔX: +181.000000000ms, 1/ΔX: +5.5249Hz, ΔY(4): +0.0V

Cursors Menu: Mode Manual, Source 4, Cursors X1 X2, Units ↓

X1: -6.134000000000s Y1: 65.0000V
 X2: -5.953000000000s Y2: 65.0000V

Overfrequency 51.5 Hz- Test 2

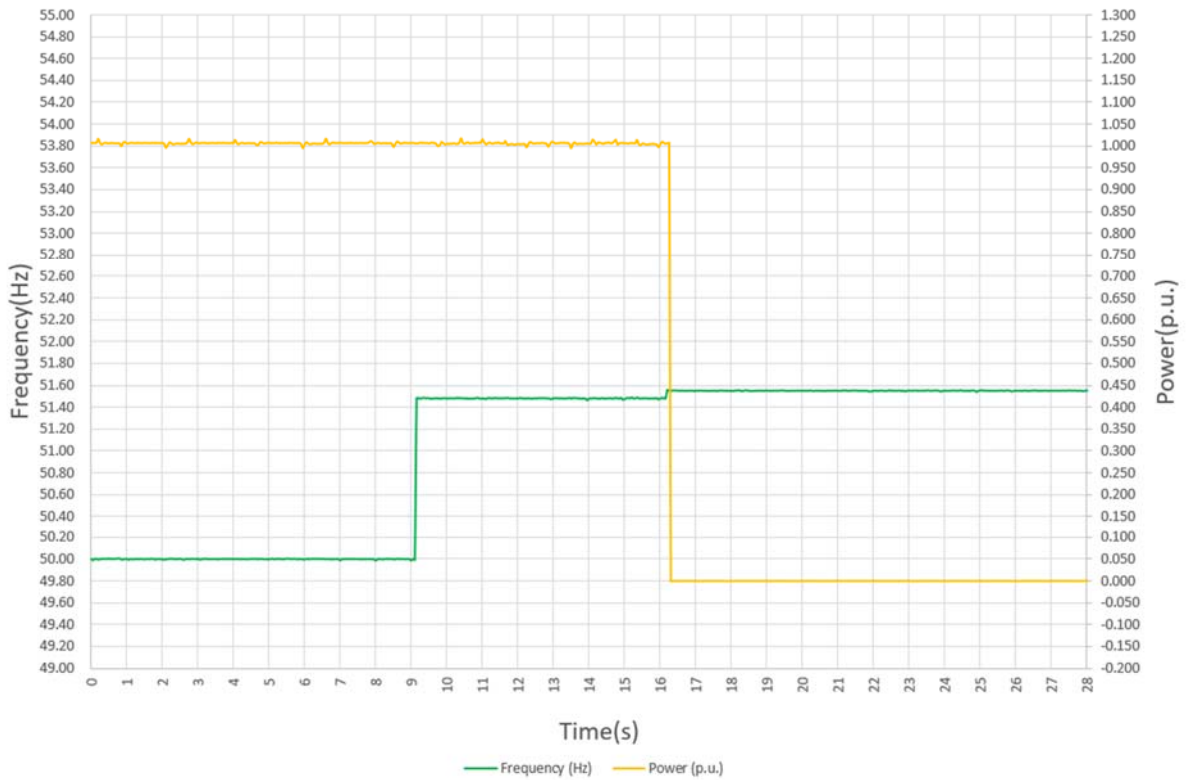

DSO-X 3014A, MY58101647: Tue Jul 28 10:08:25 2020

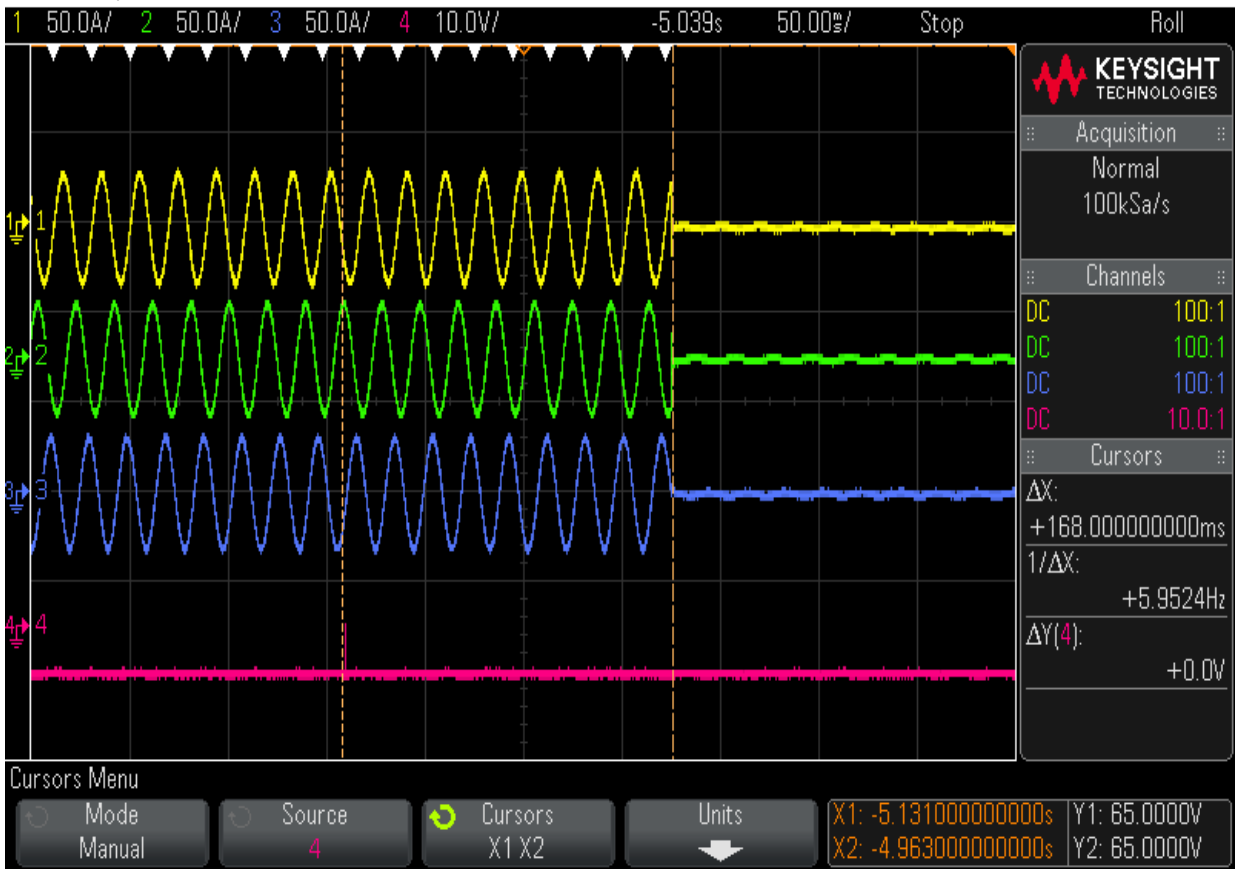

Overfrequency 51.5 Hz- Test 3

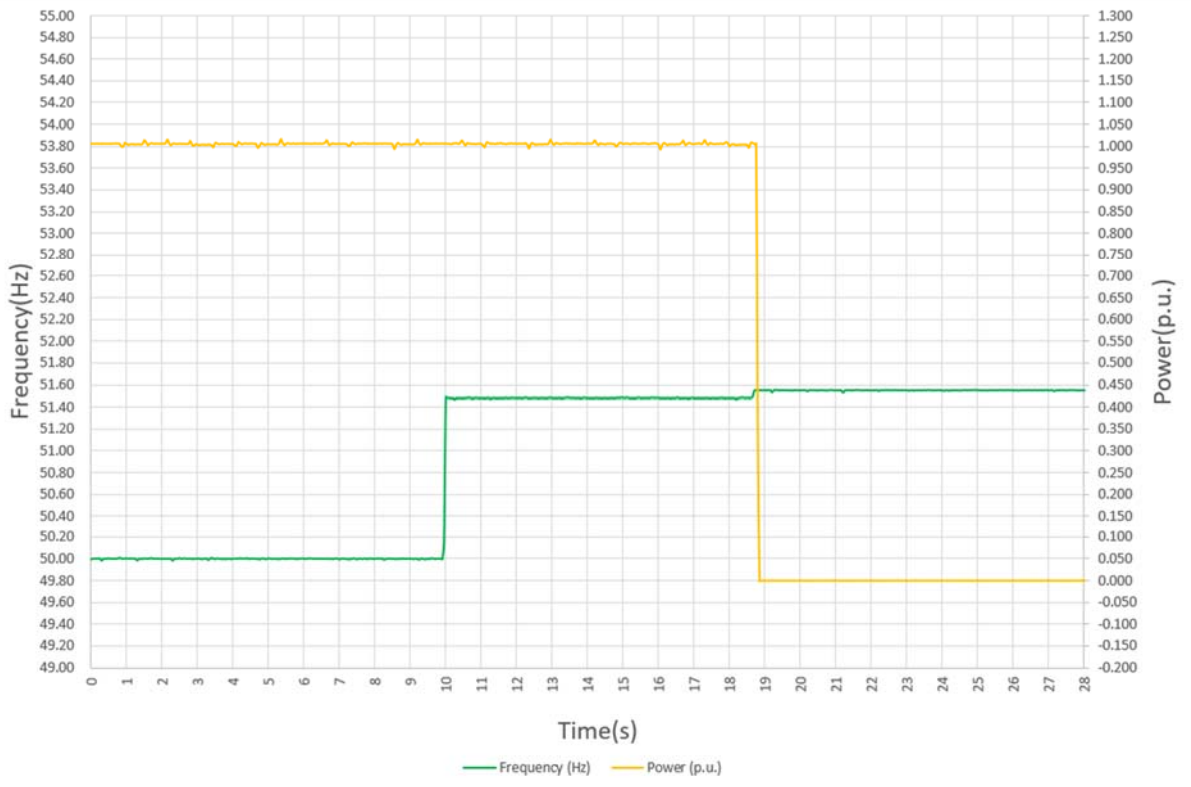

DSO-X 3014A, MY58101647: Tue Jul 28 10:09:57 2020

1 50.0A/ 2 50.0A/ 3 50.0A/ 4 10.0V/ -5.053s 50.00% Stop Roll

KEYSIGHT TECHNOLOGIES

Acquisition: Normal, 100kSa/s

Channels: DC 100:1, DC 100:1, DC 100:1, DC 10.0:1

Cursors: ΔX: +176.000000000ms, 1/ΔX: +5.6818Hz, ΔY(4): +0.0V

Cursors Menu: Mode Manual, Source 4, Cursors X1 X2, Units

X1: -5.163000000000s Y1: 65.0000V
X2: -4.987000000000s Y2: 65.0000V

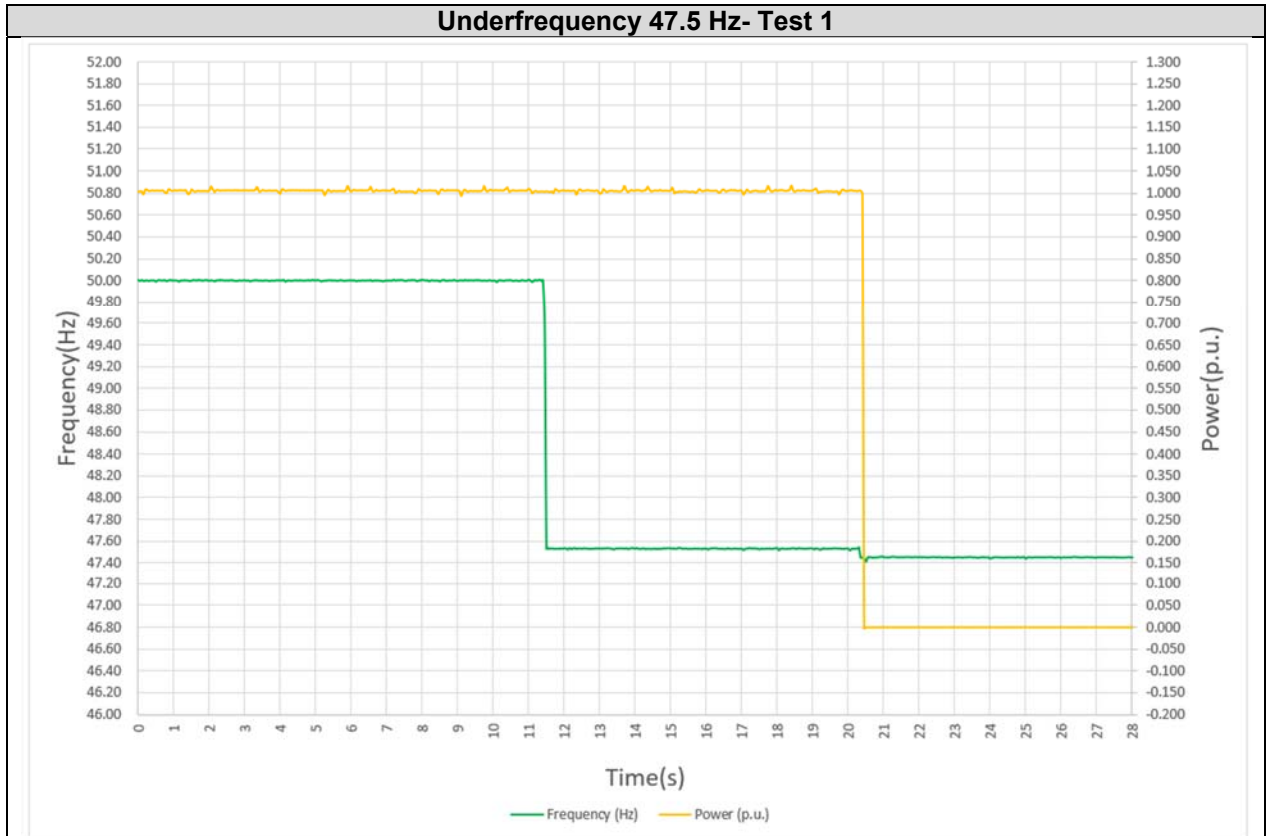

DSO-X 3014A, MY58101647: Tue Jul 28 10:11:11 2020

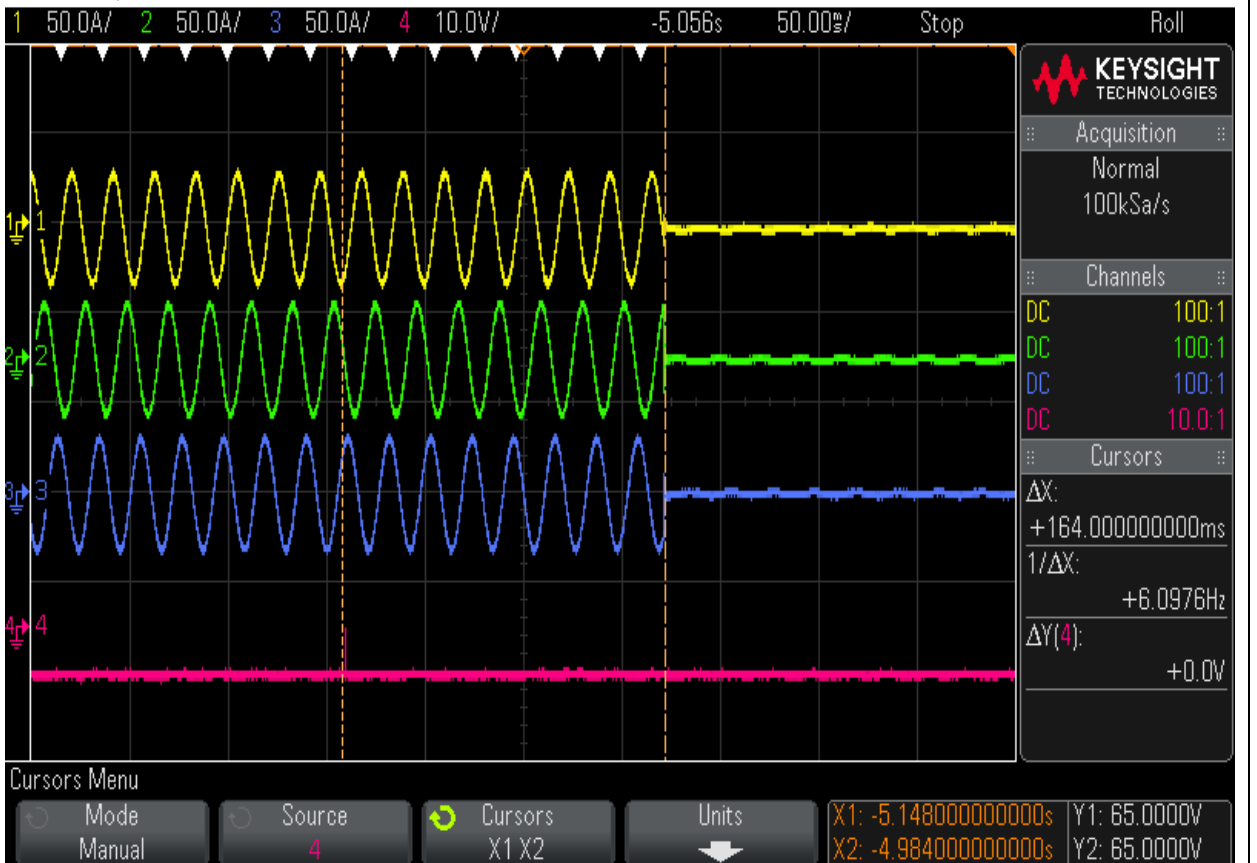

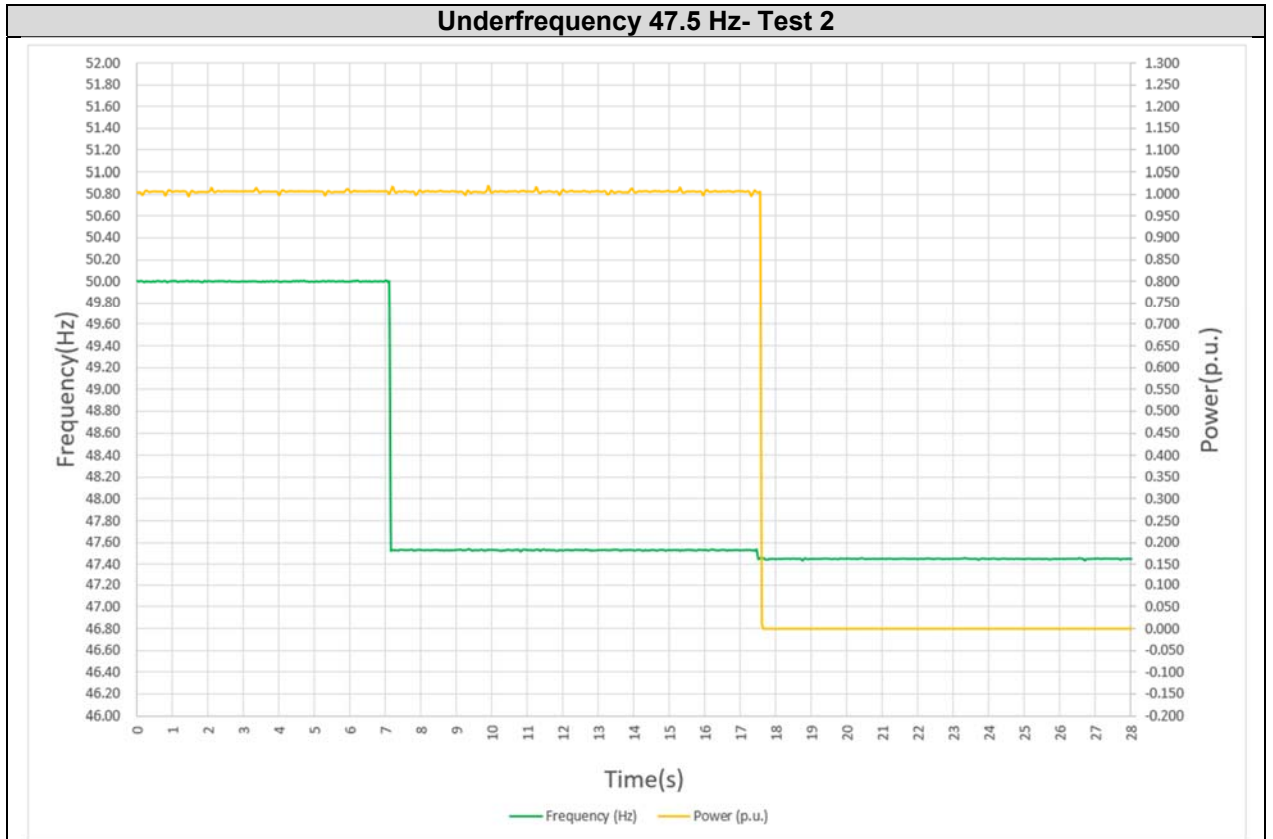

DSO-X 3014A, MY58101647: Tue Jul 28 10:12:56 2020

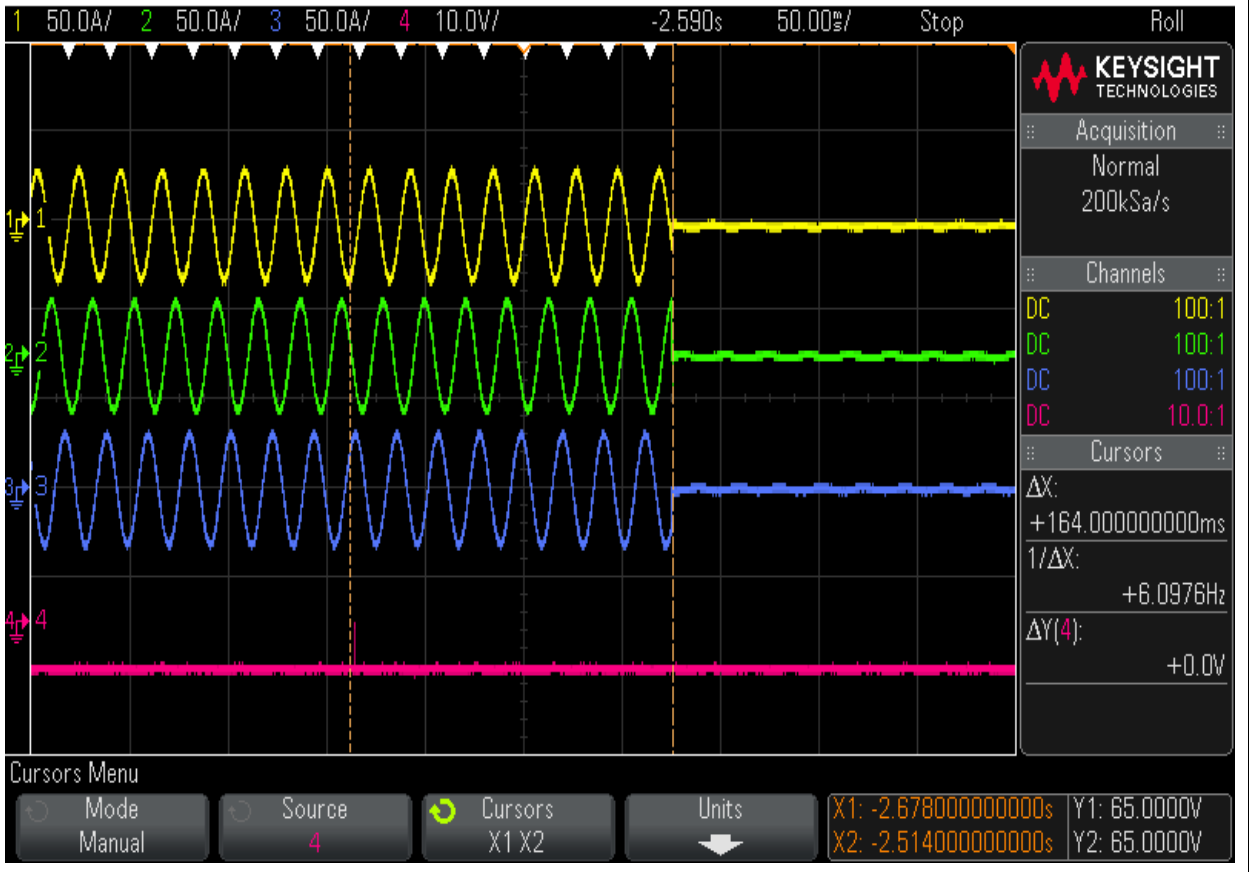

Underfrequency 47.5 Hz- Test 3

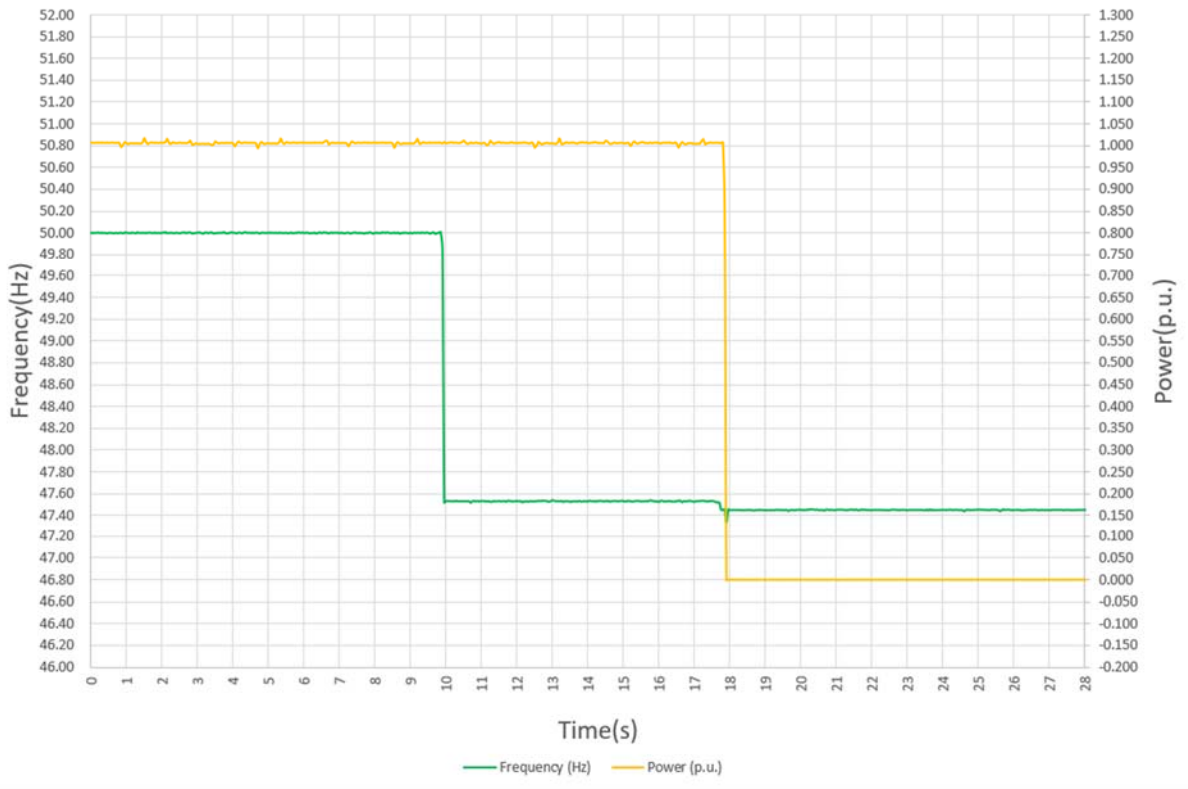

DSO-X 3014A, MY58101647: Tue Jul 28 10:16:28 2020

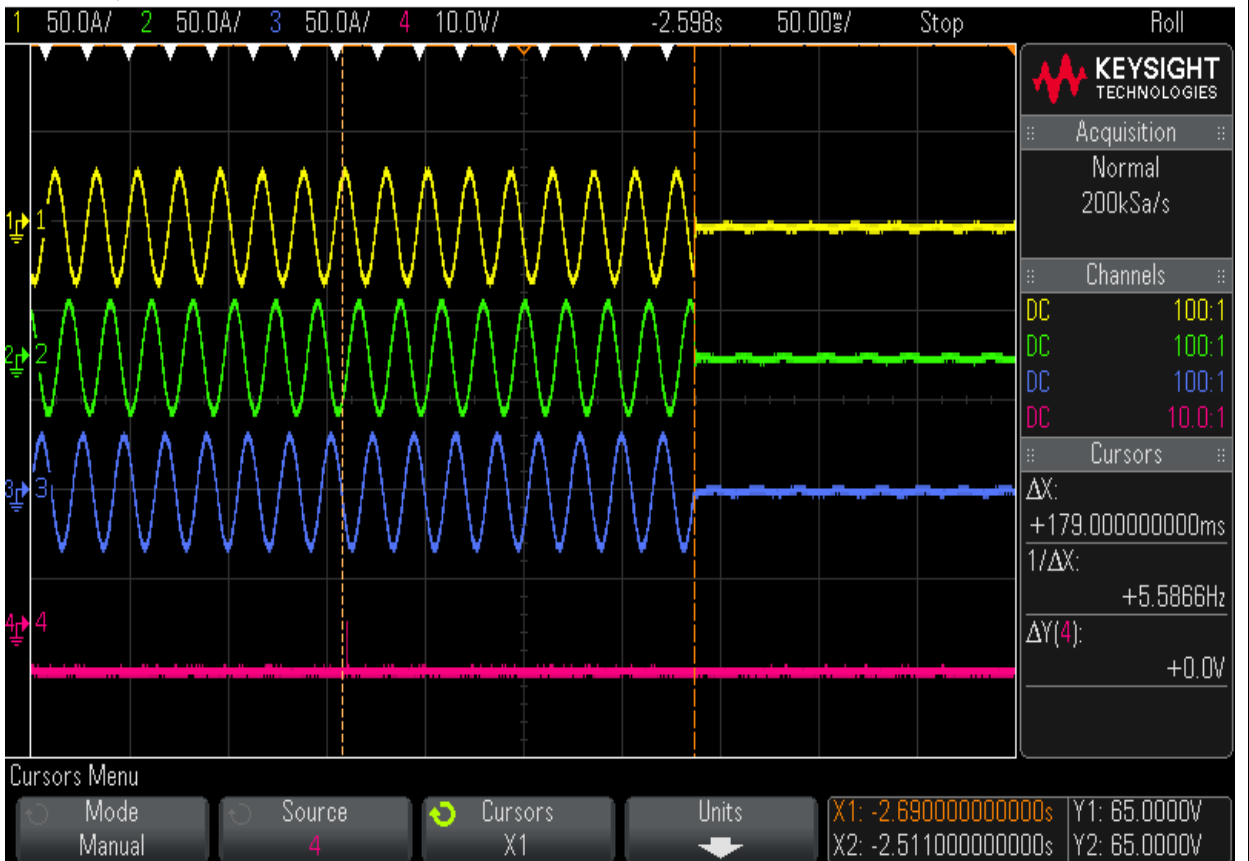

4.5 DC CURRENT MONITORING

The verification of the protection against DC component emission test has been measured according to the standard, at the required active power levels.

(I > 1 A)			
Output Power %	(33 ± 5) %	(66 ± 5) %	(100 ± 5) %
Time (ms) Time Limit (200 ms)	165	162	163

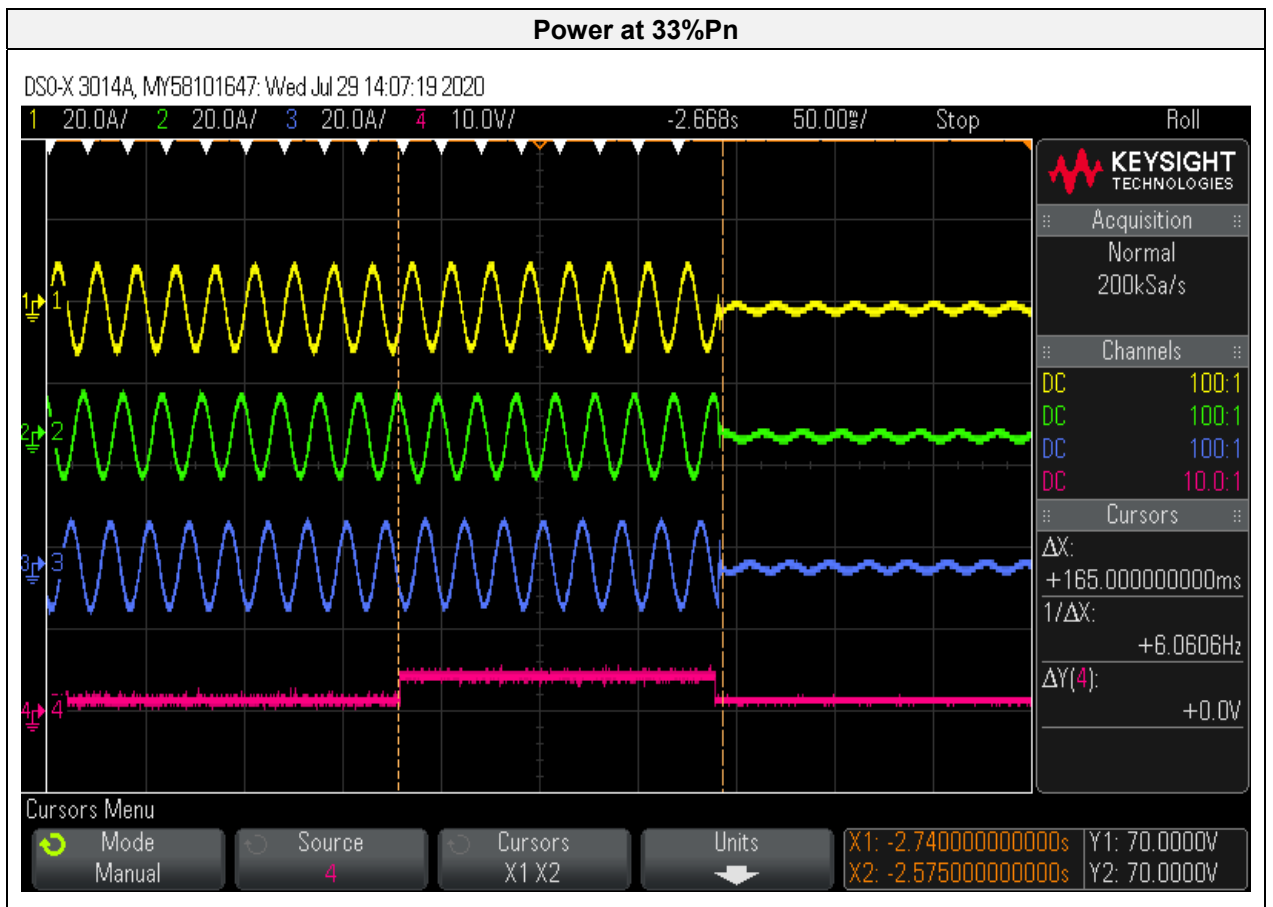

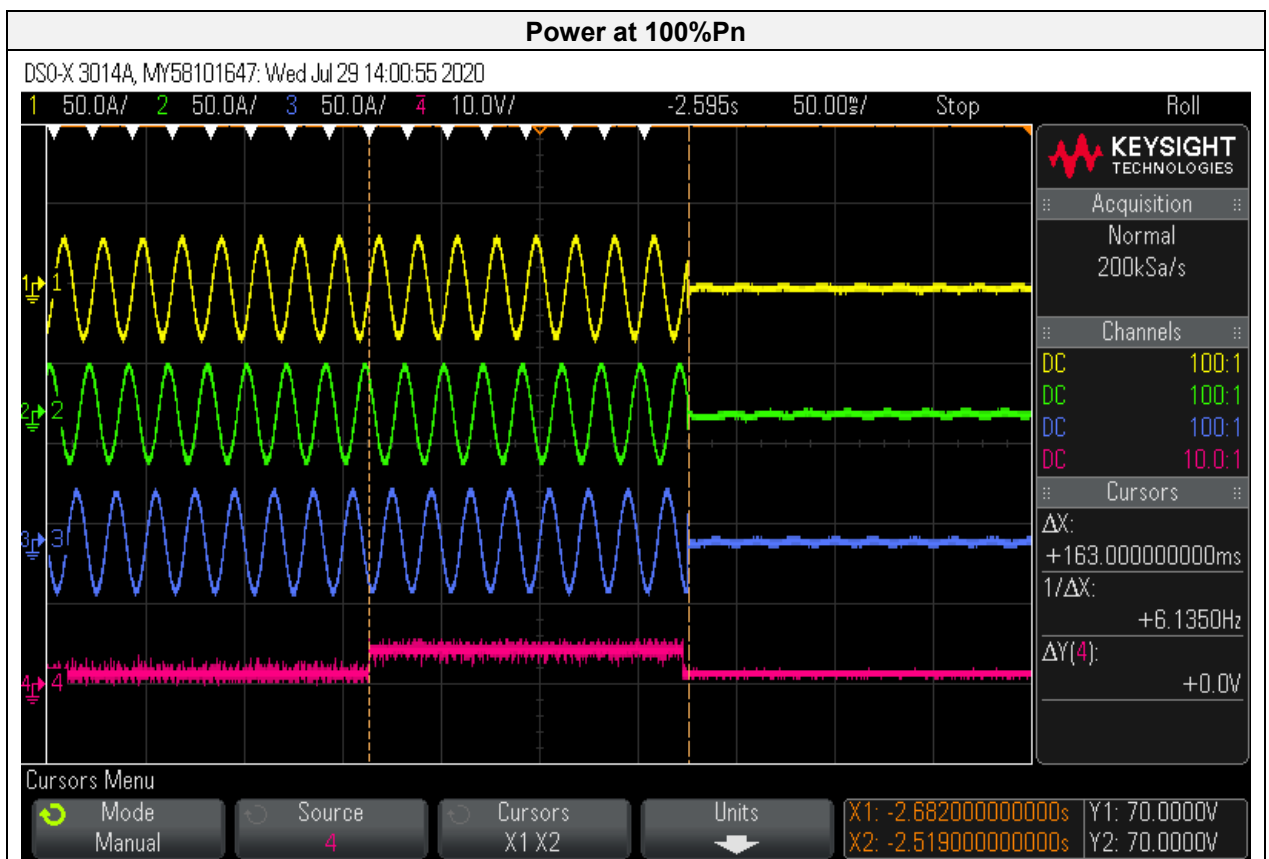
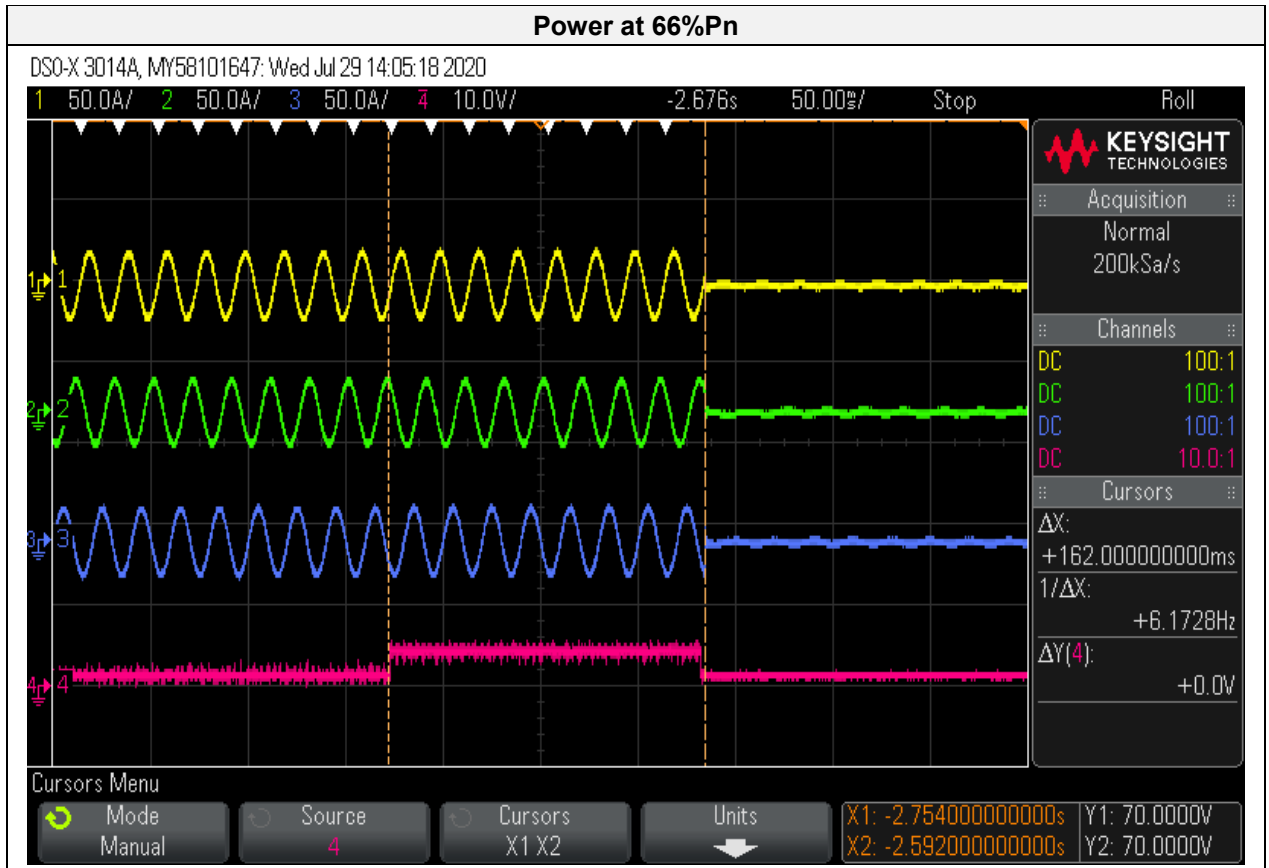

4.6 ANTI ISLANDING PROTECTION

This test has been performed according to the point 6.5.3 of VDE-AR-N 4105:2011-08 and the paragraph 5.4.6 of VDE V 0124-100:2012-07.

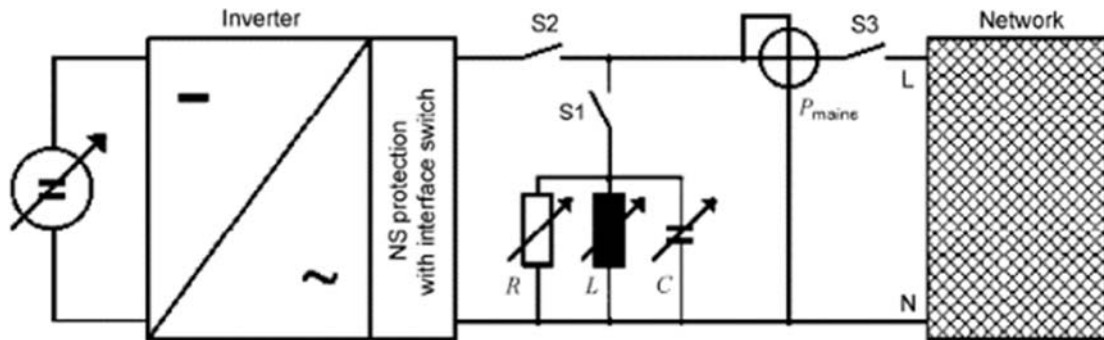

All the tests and checks have been performed in accordance with the reference Standard as specified previously. The used quality factor of resonant load was $Q_f=2$.

There are required three different tests:

Test A is at full power

Test B is at 50%P_n

Test C is at 20%P_n

4.6.1 Test A

Balanced Load		Disconnection (ms) (limit at t=5s)
M (%)	N (%)	
0	-5	424
0	-4	488
0	-3	414
0	-2	458
0	-1	454
0	0	504
0	1	394
0	2	386
0	3	414
0	4	466
0	5	434

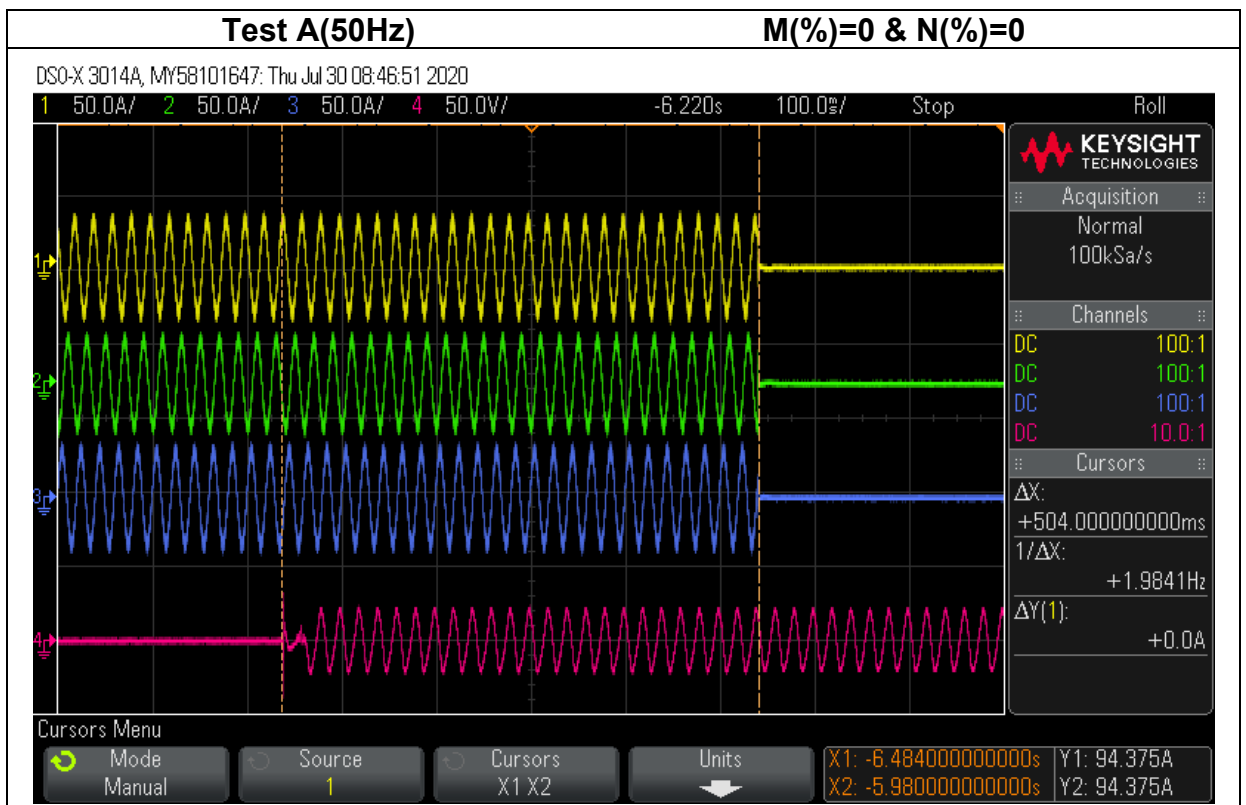
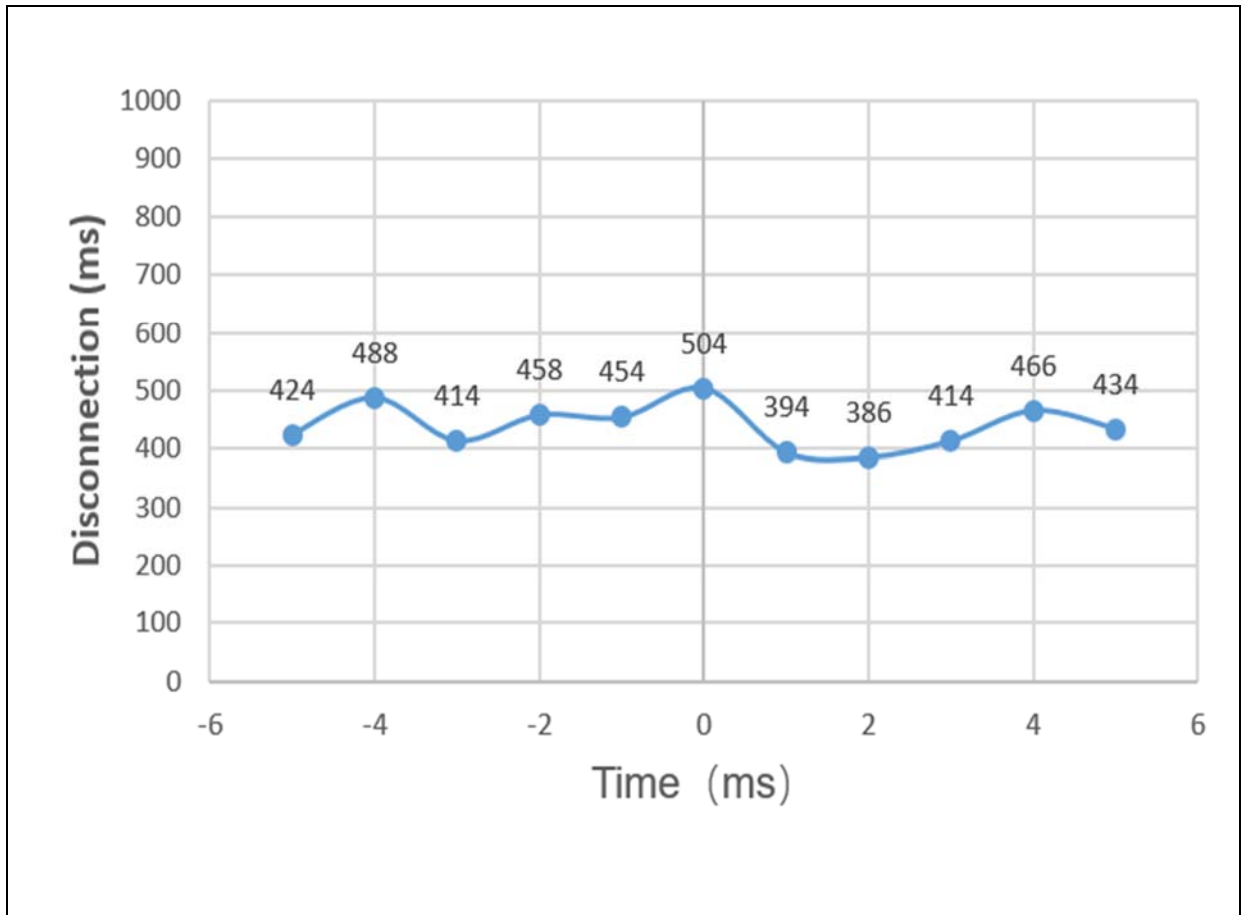

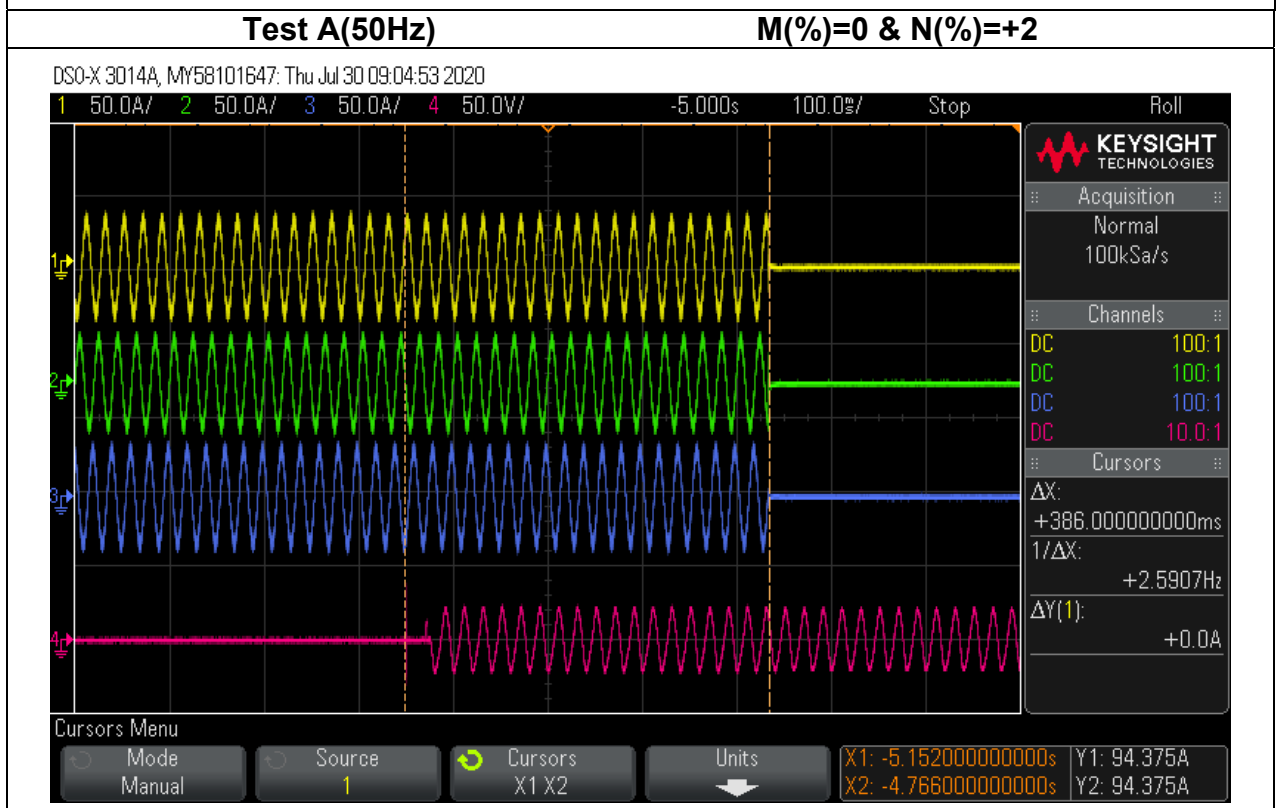
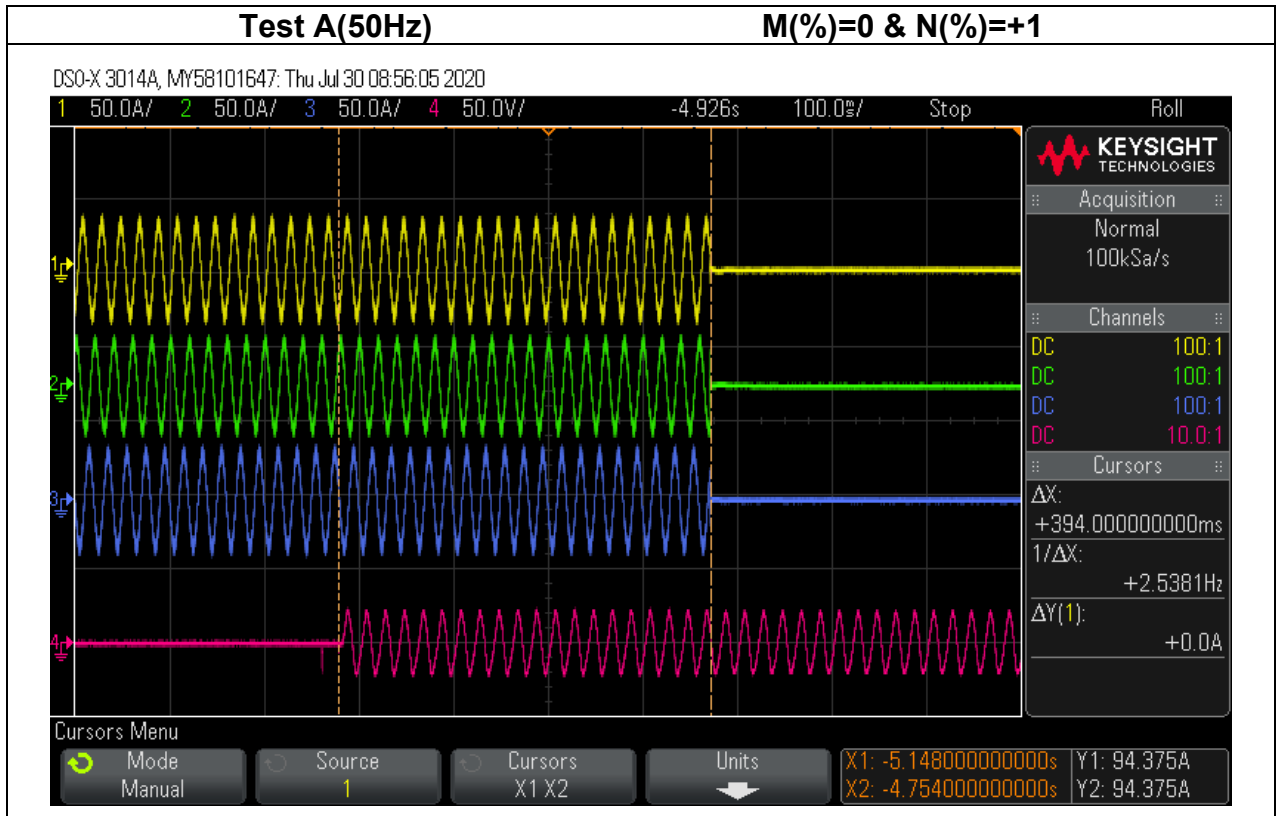

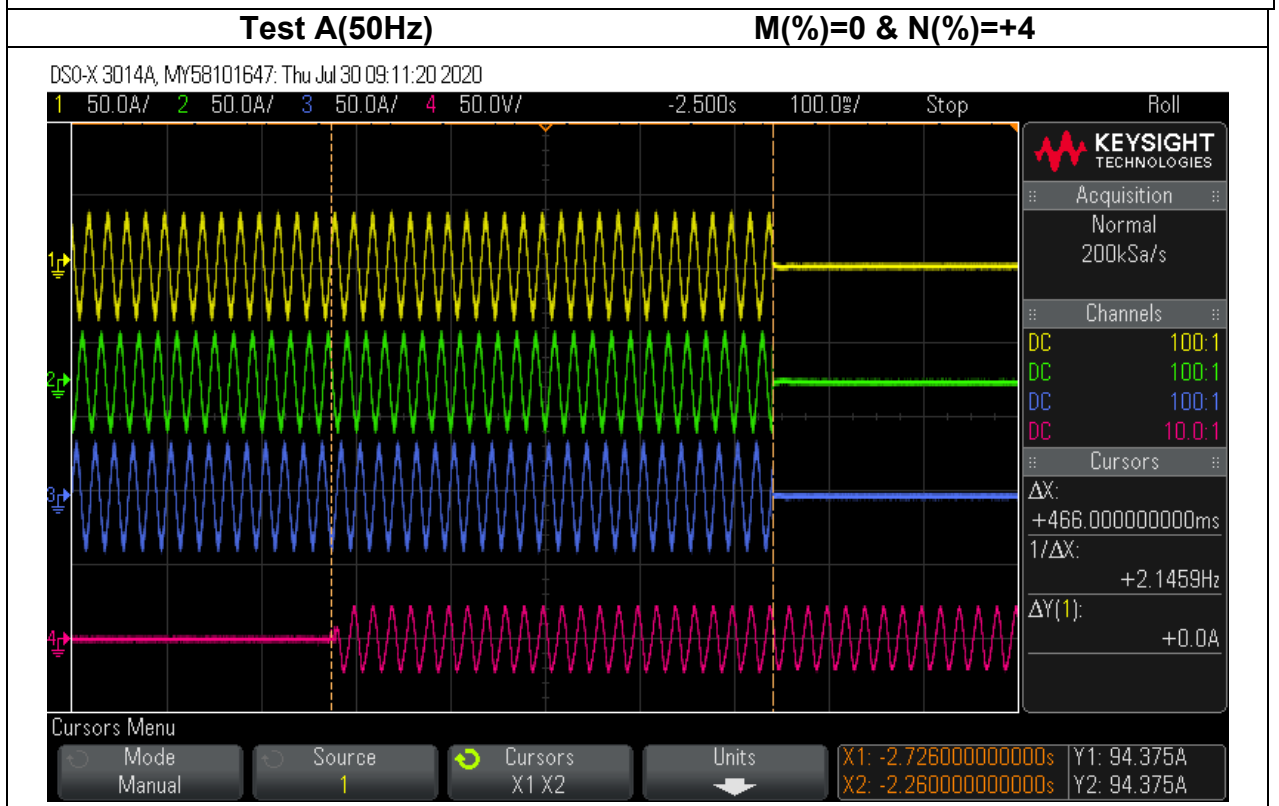
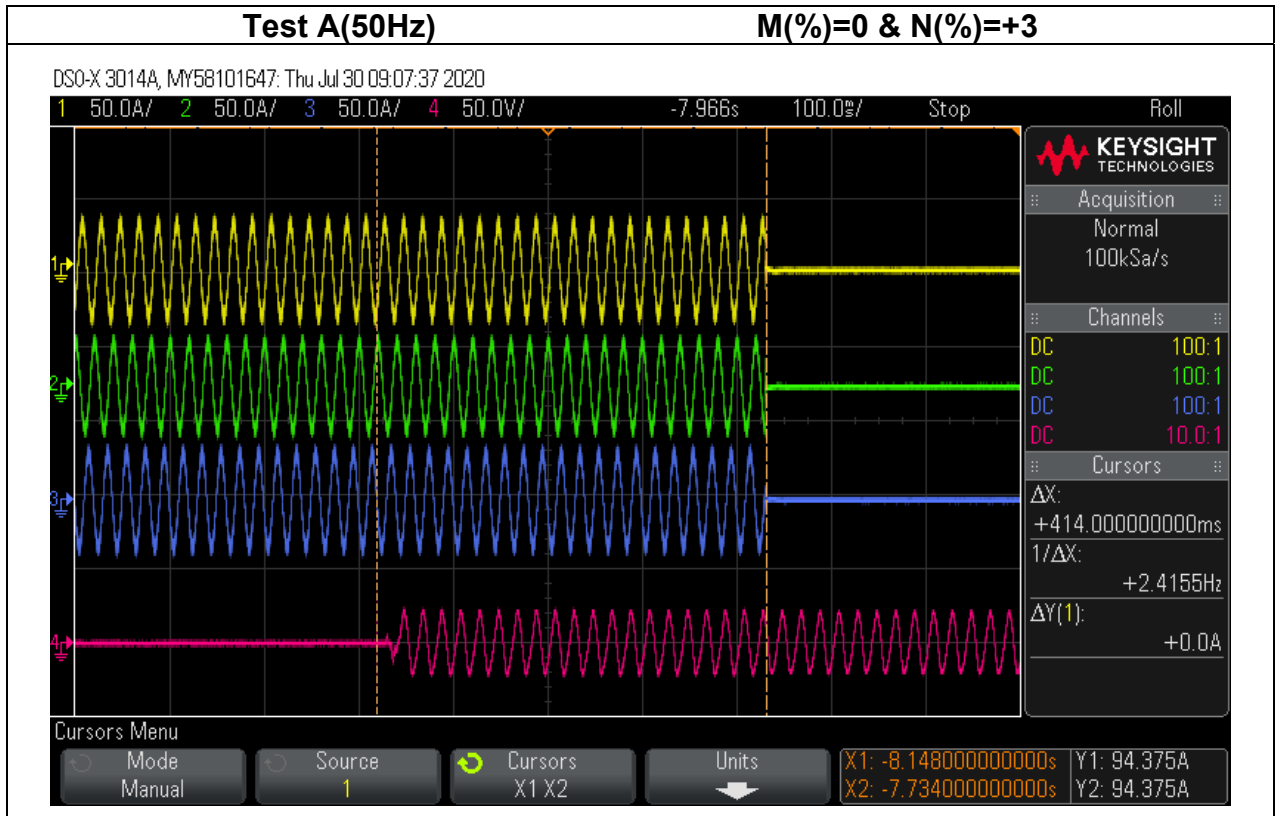

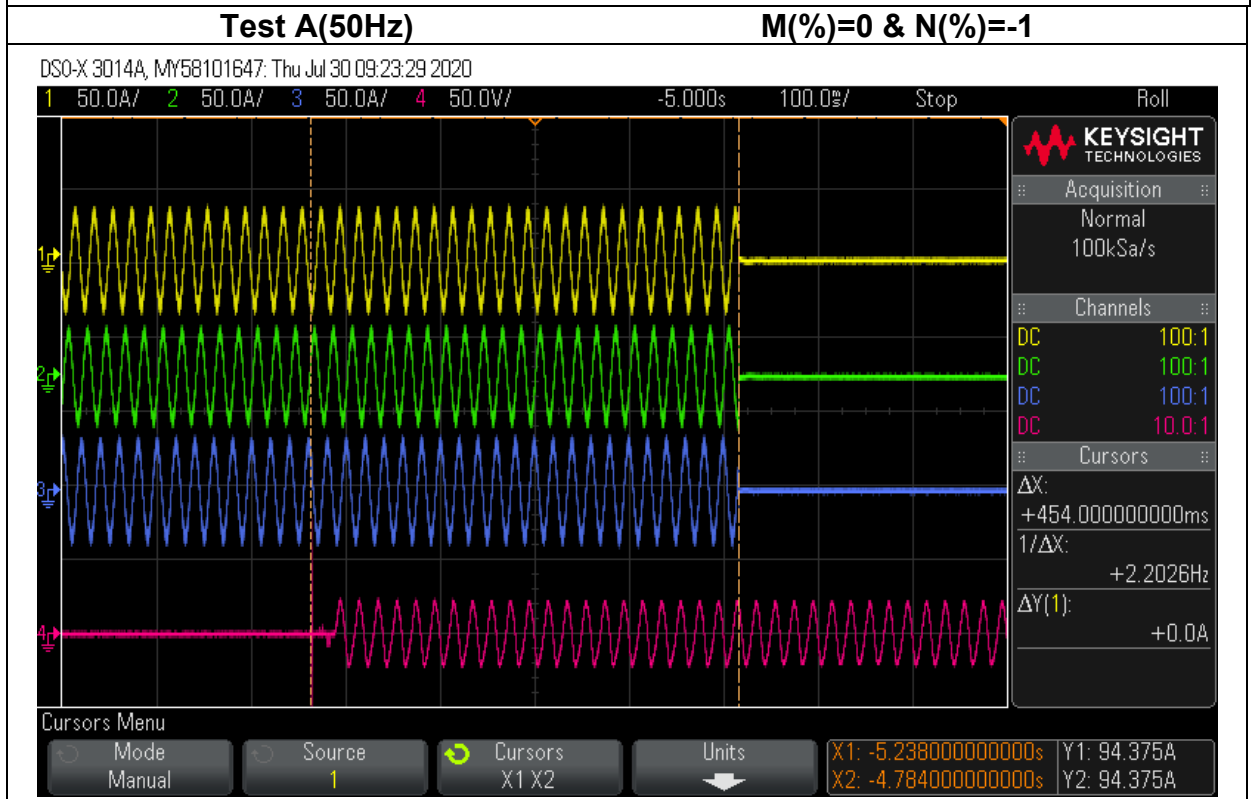
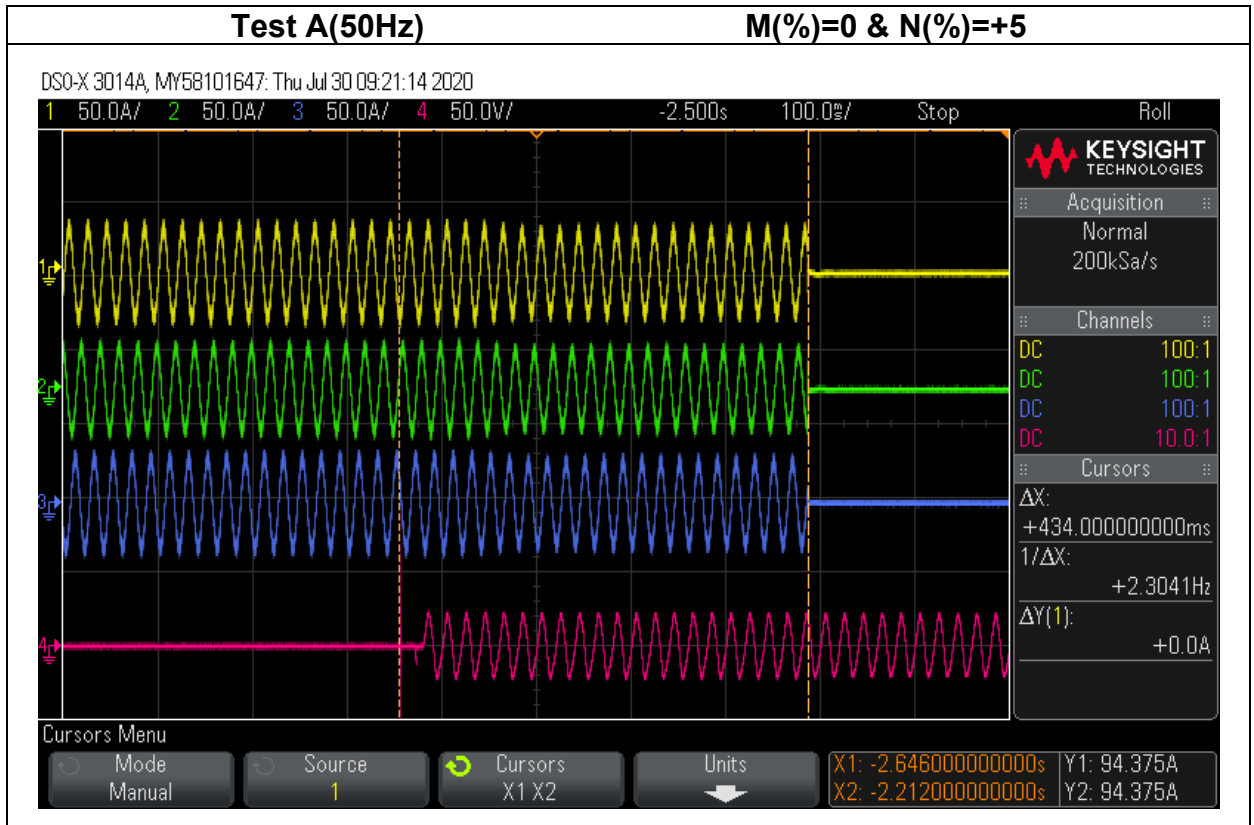

Test A(50Hz)

M(%)=0 & N(%)=-2

DSO-X 3014A, MY58101647: Thu Jul 30 09:27:53 2020

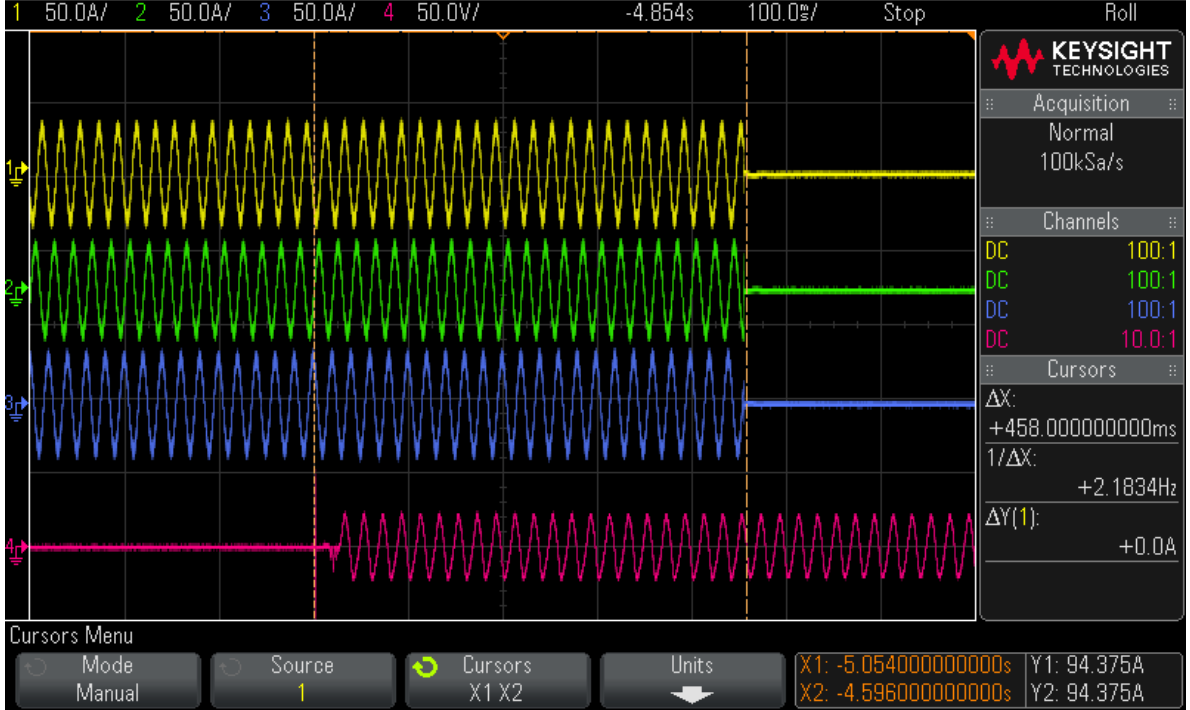

Test A(50Hz)

M(%)=0 & N(%)=-3

DSO-X 3014A, MY58101647: Thu Jul 30 09:31:51 2020

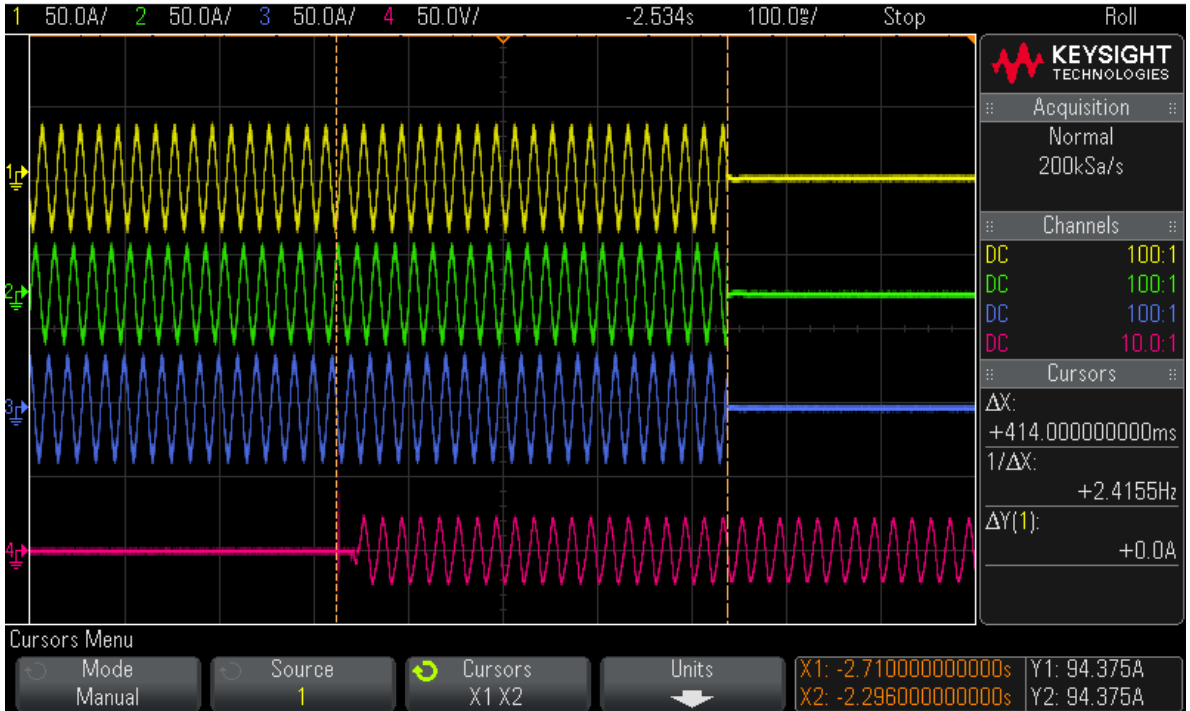

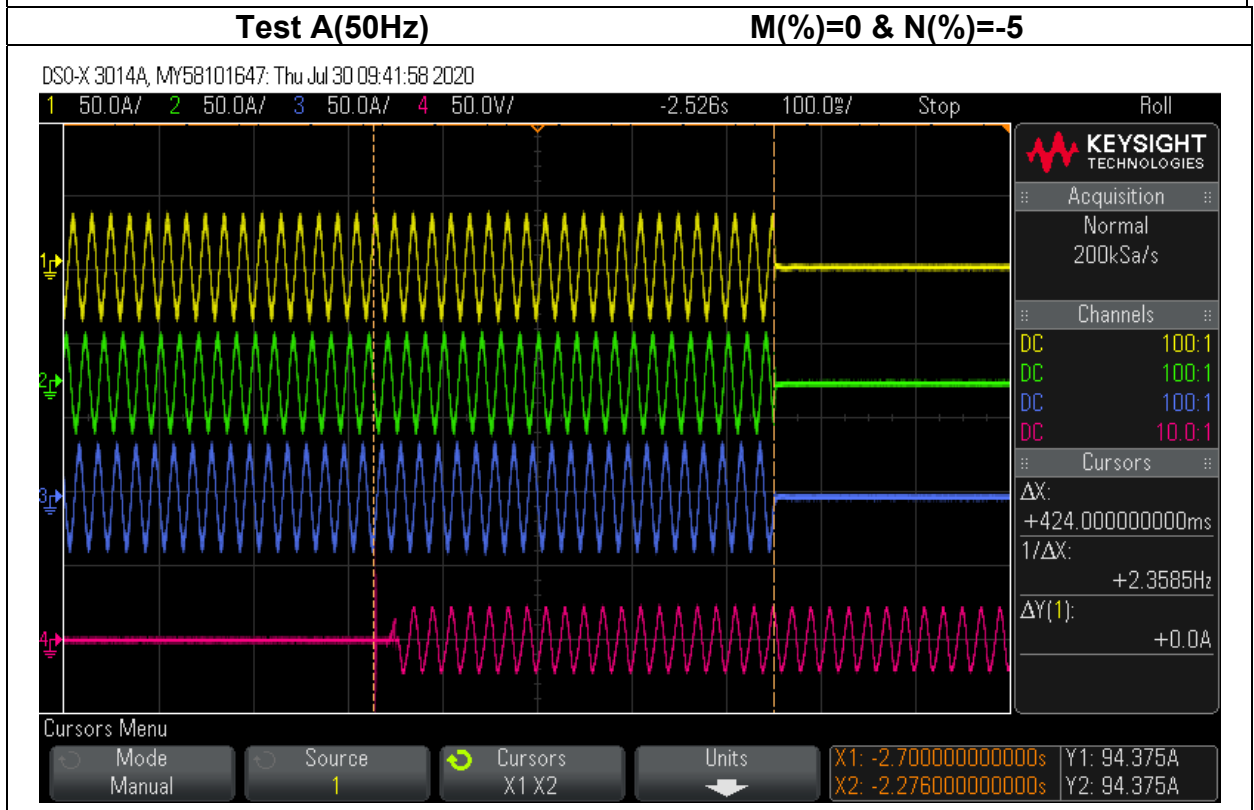
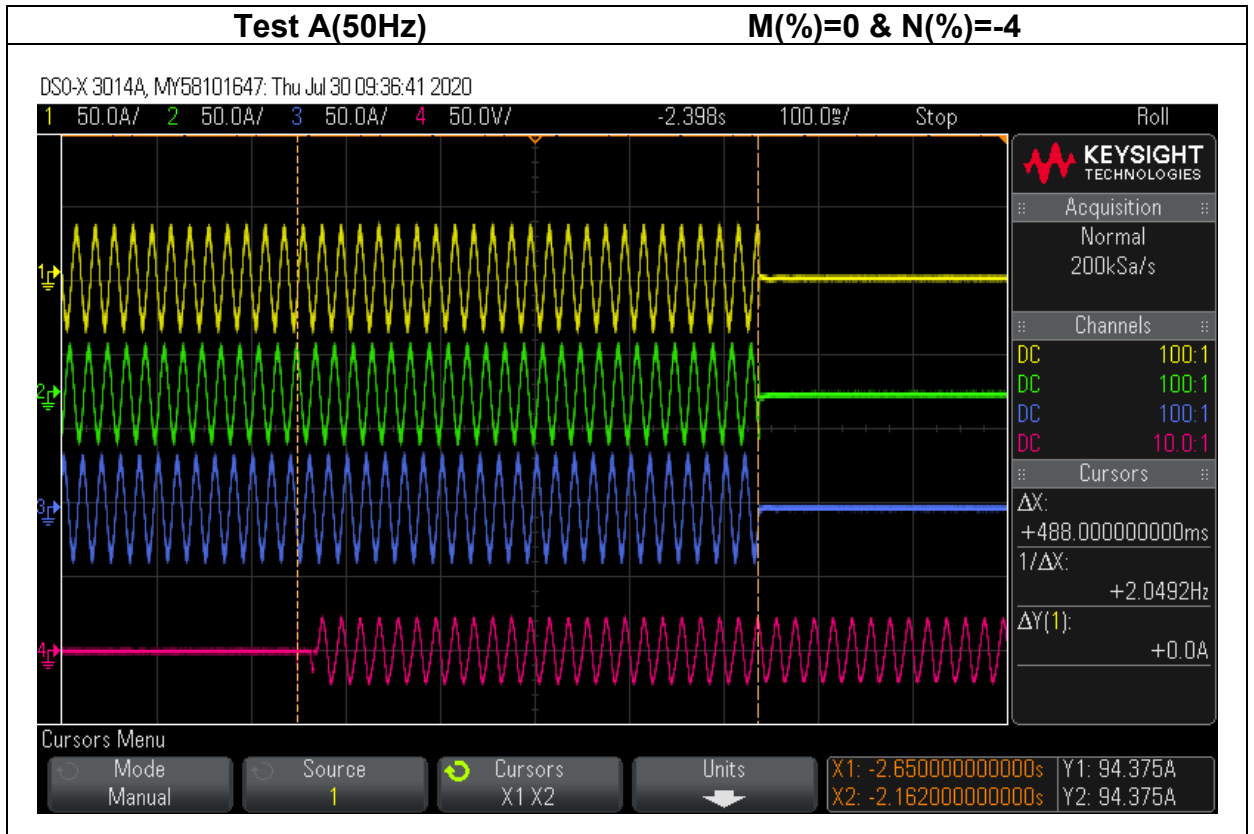

4.6.2 Test B

Balanced Load		Disconnection (ms) (limit at t=5s)
M (%)	N (%)	
0	-5	418
0	-4	454
0	-3	496
0	-2	462
0	-1	412
0	0	504
0	1	400
0	2	366
0	3	402
0	4	396
0	5	356

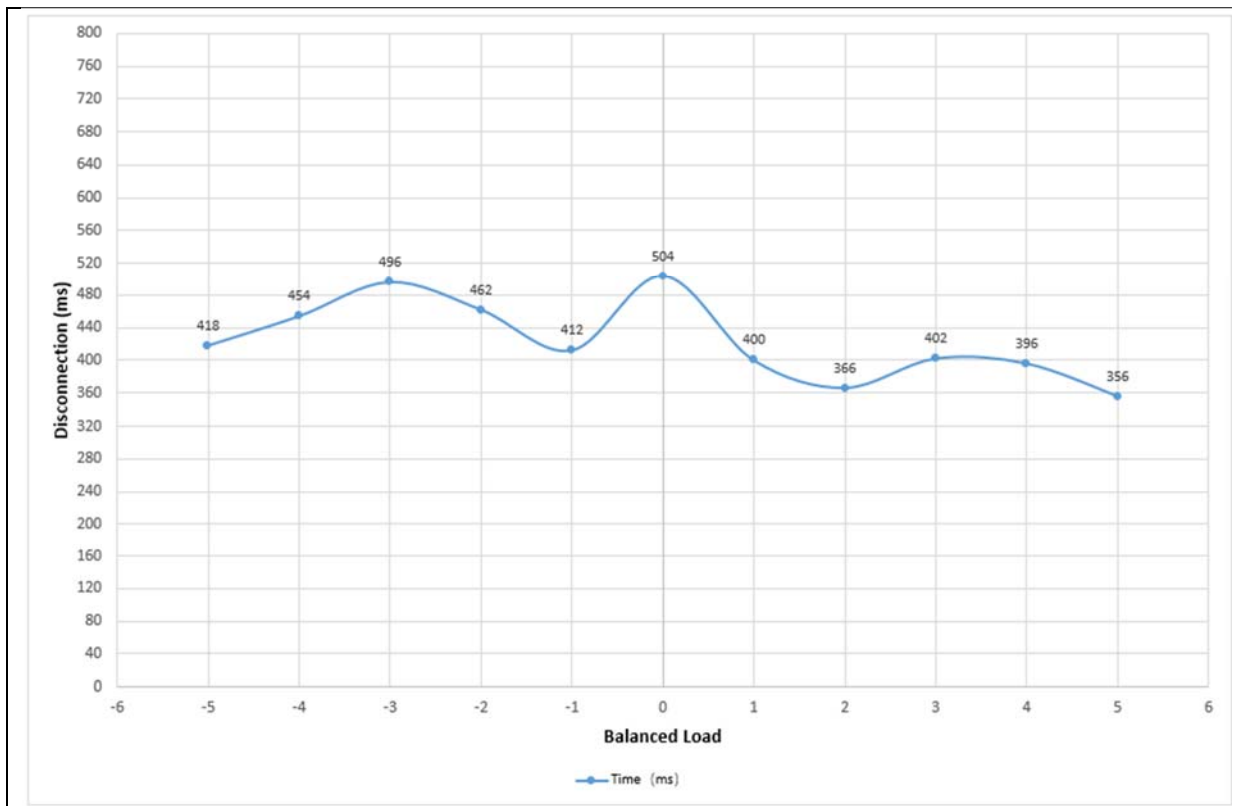

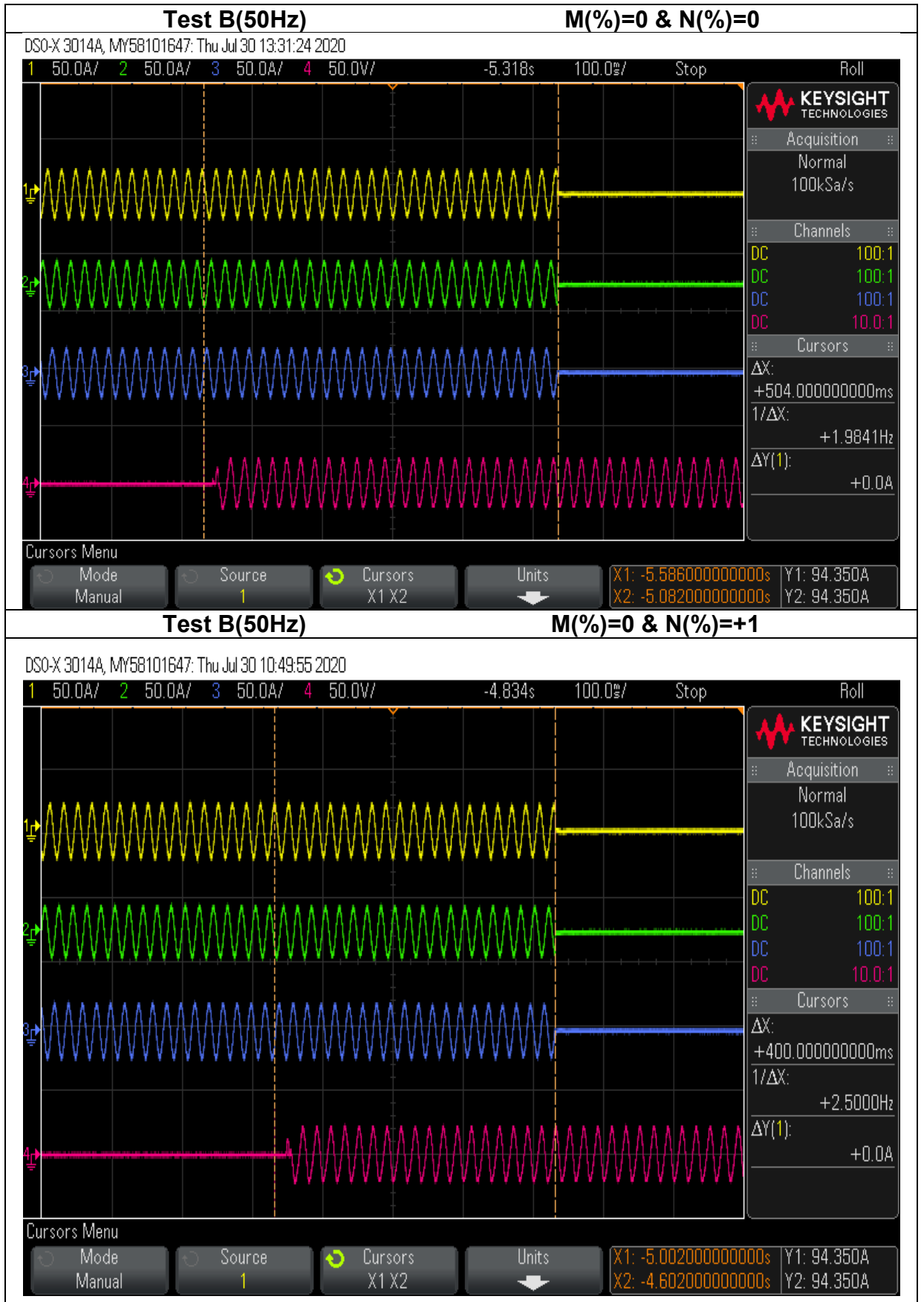

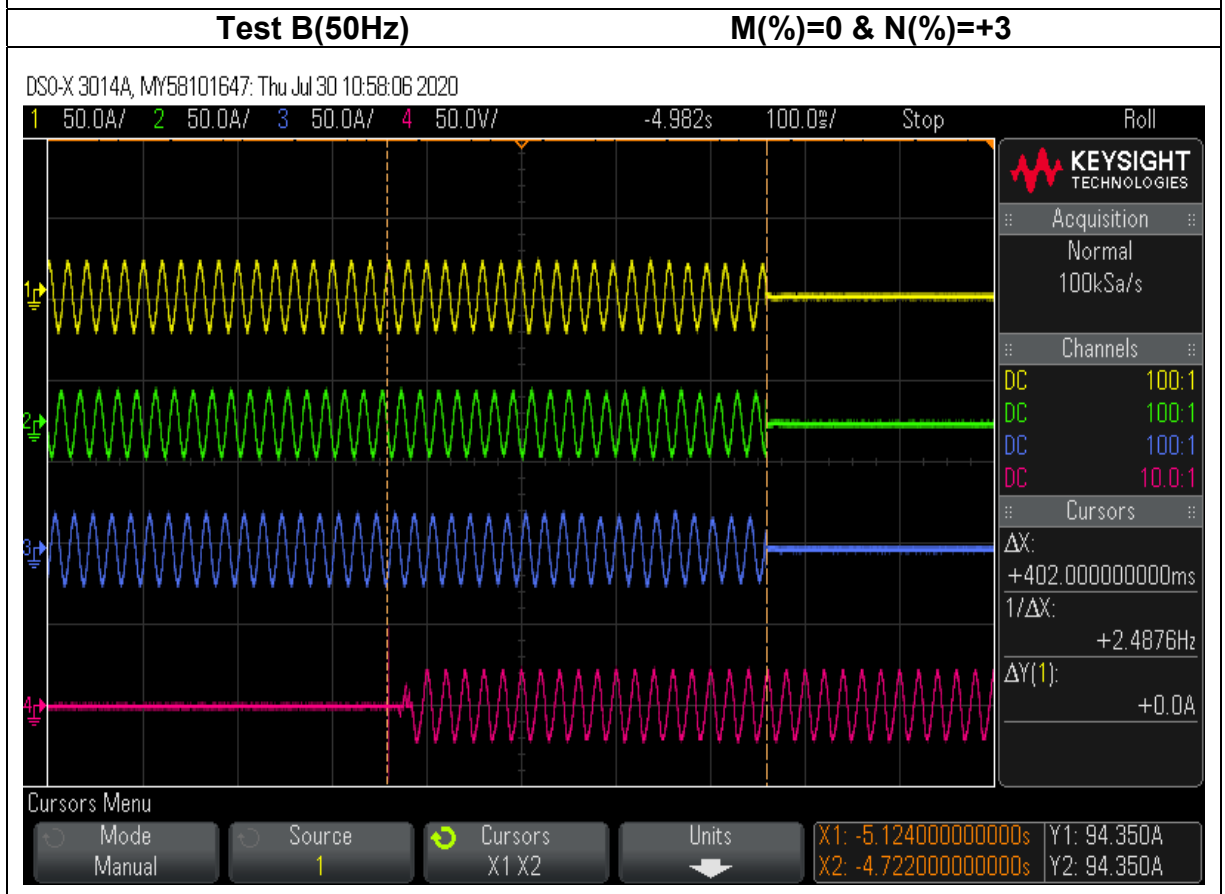
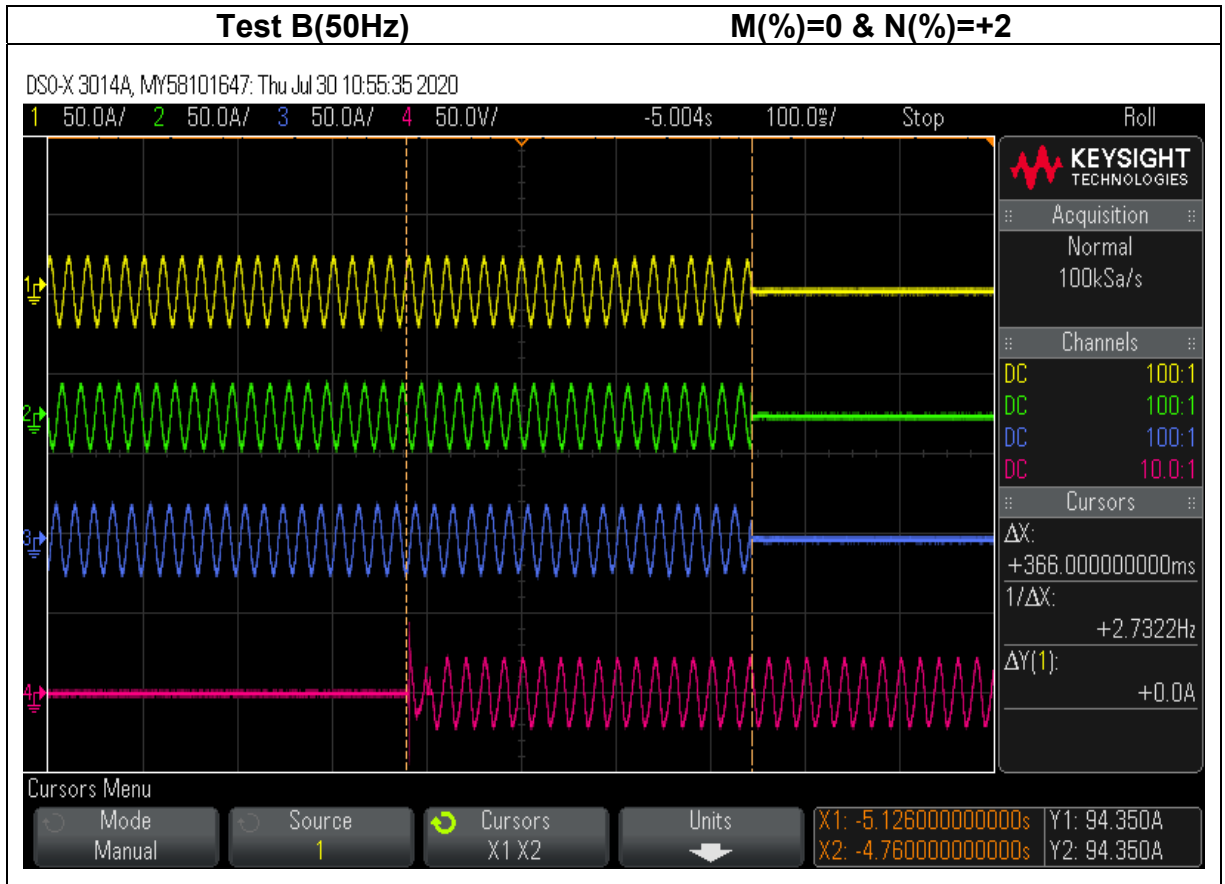

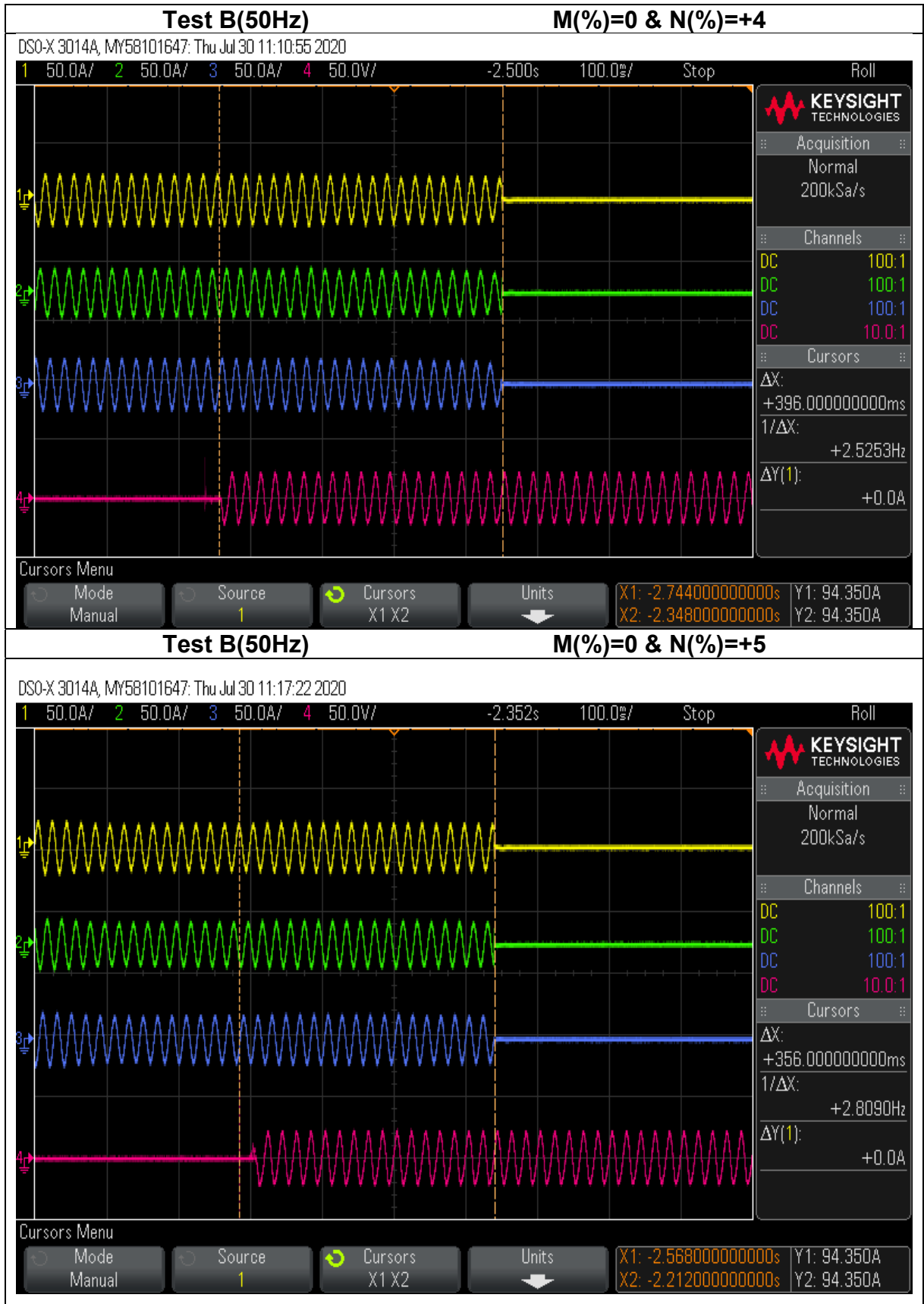

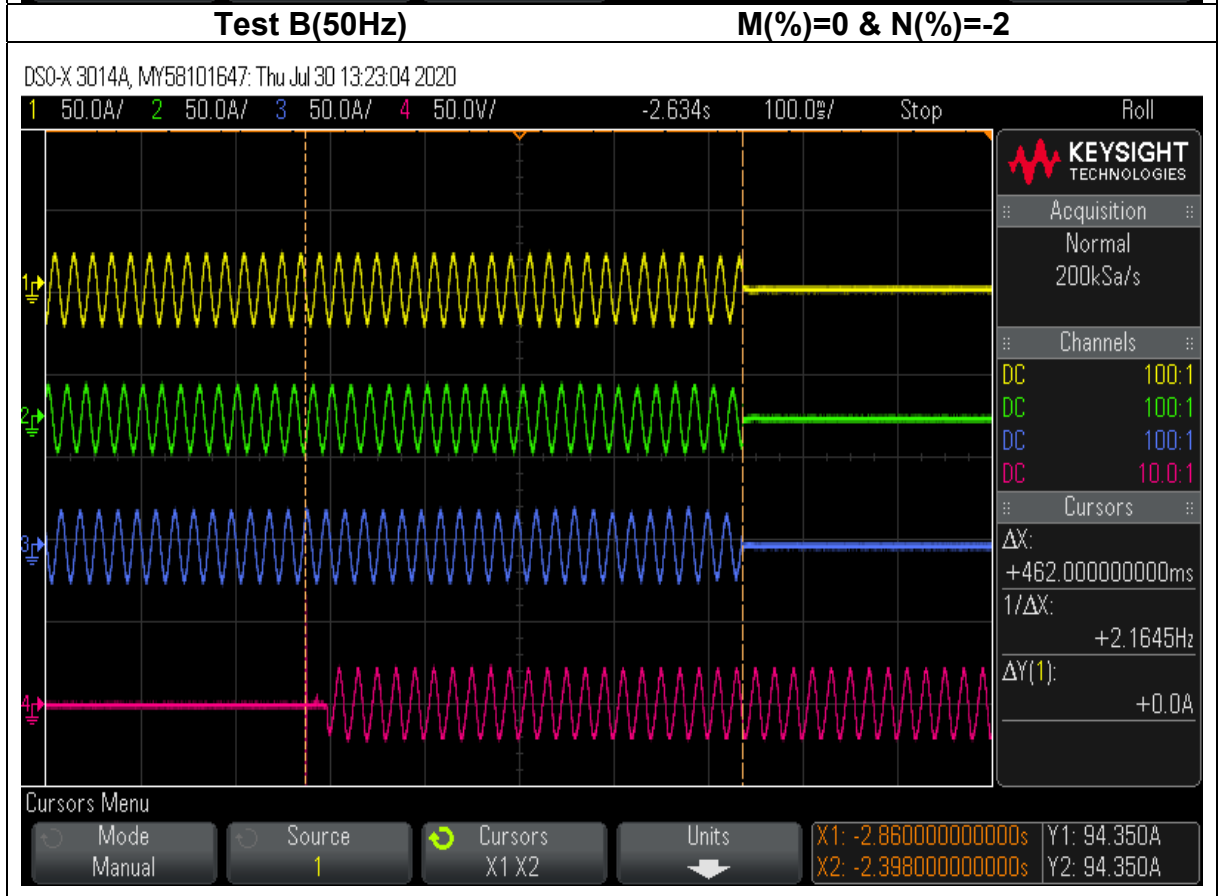
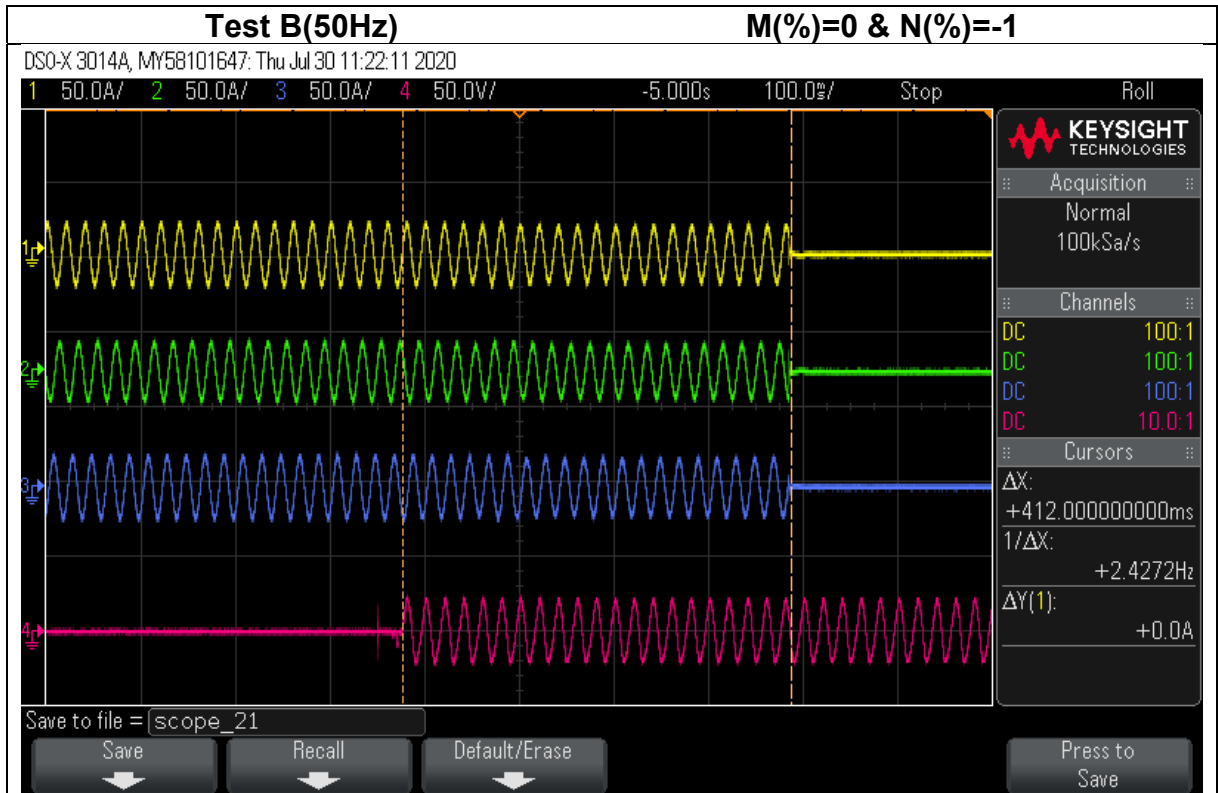

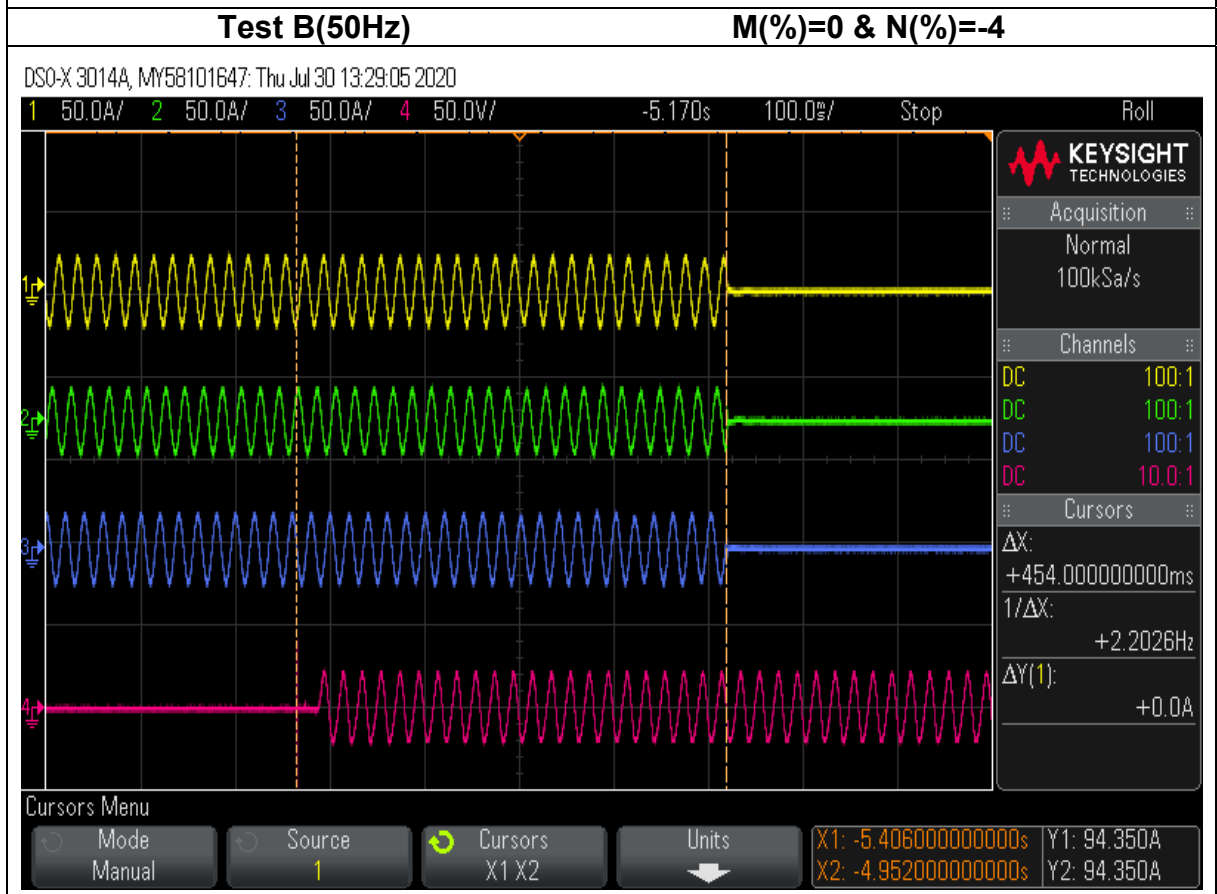
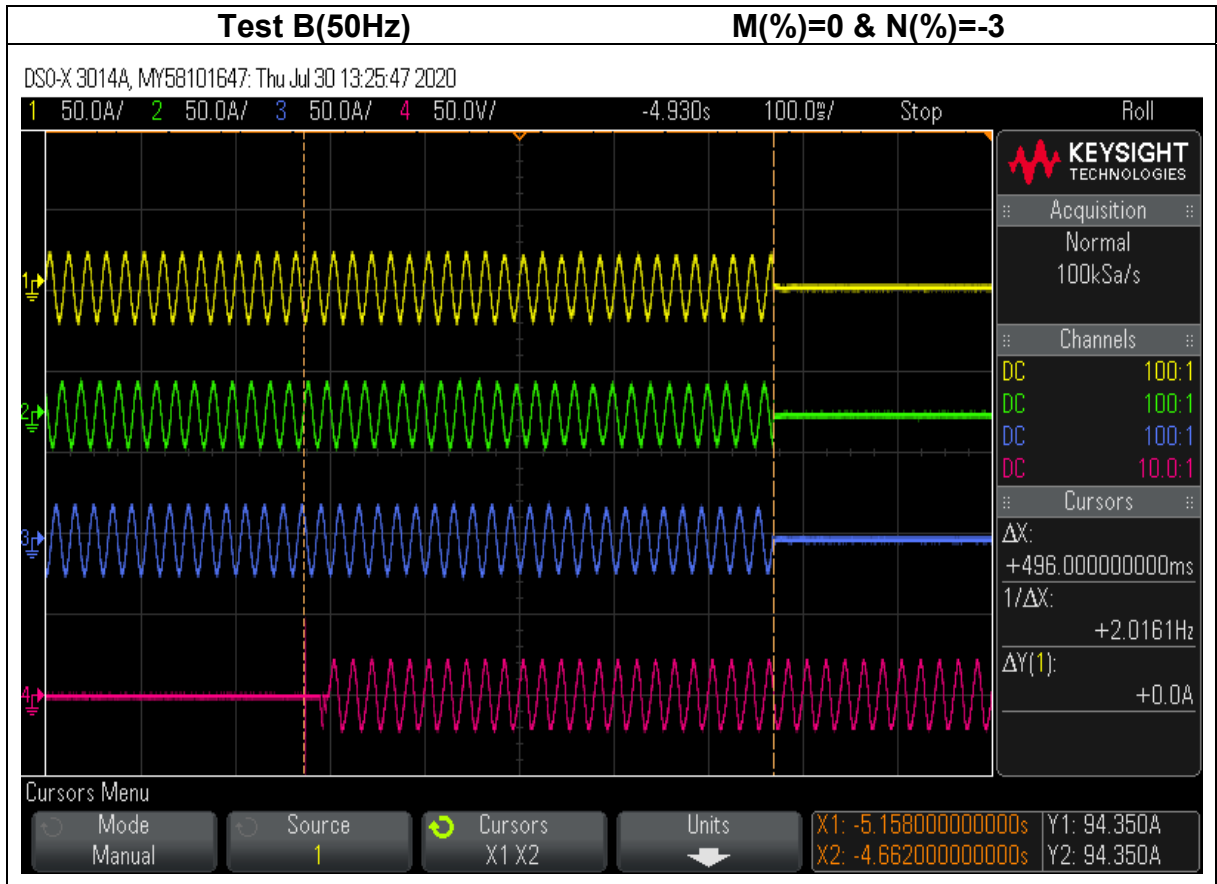

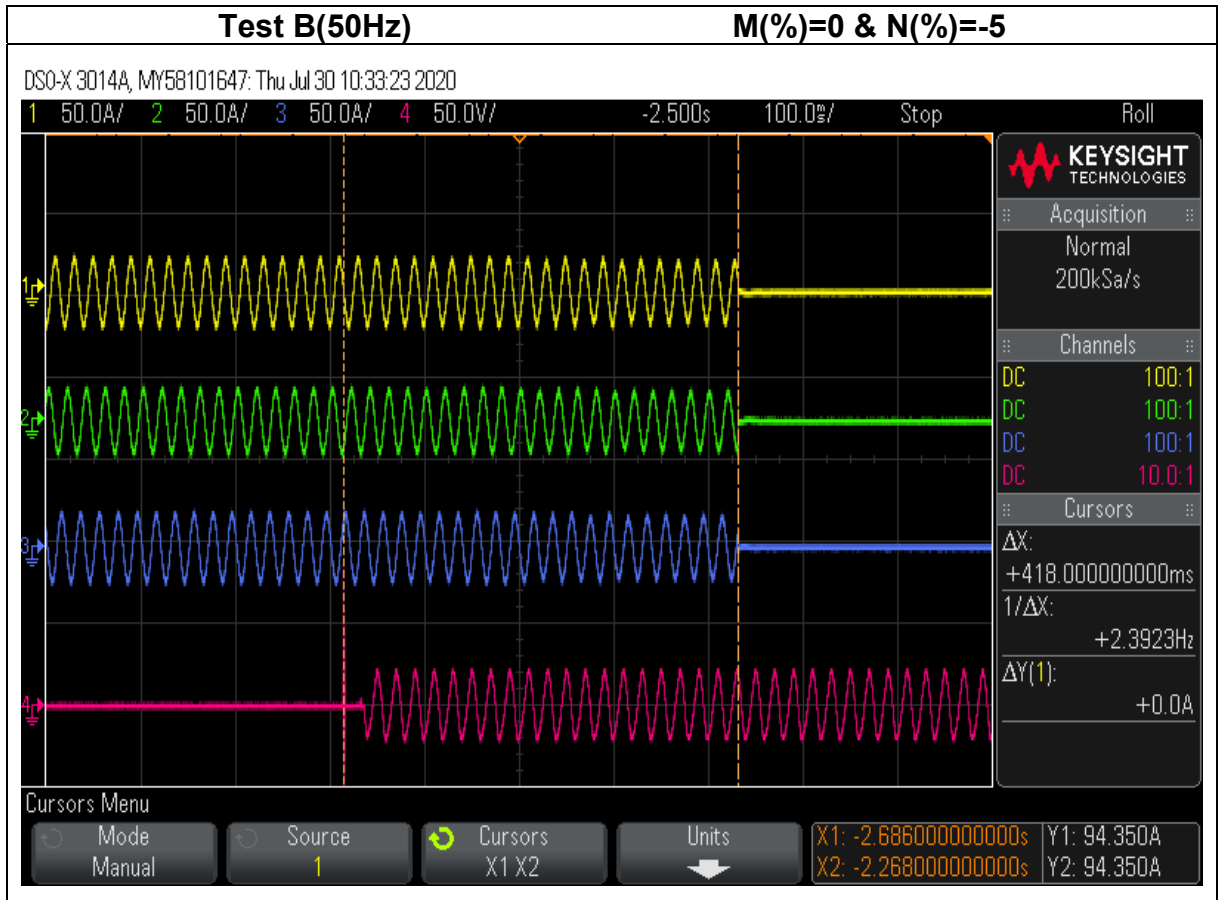

4.6.3 Test C

Balanced Load		
M (%)	N (%)	Disconnection (ms) (limit at t=5s)
0	-5	644
0	-4	762
0	-3	972
0	-2	934
0	-1	1878
0	0	1404
0	1	1102
0	2	1074
0	3	1082
0	4	852
0	5	682

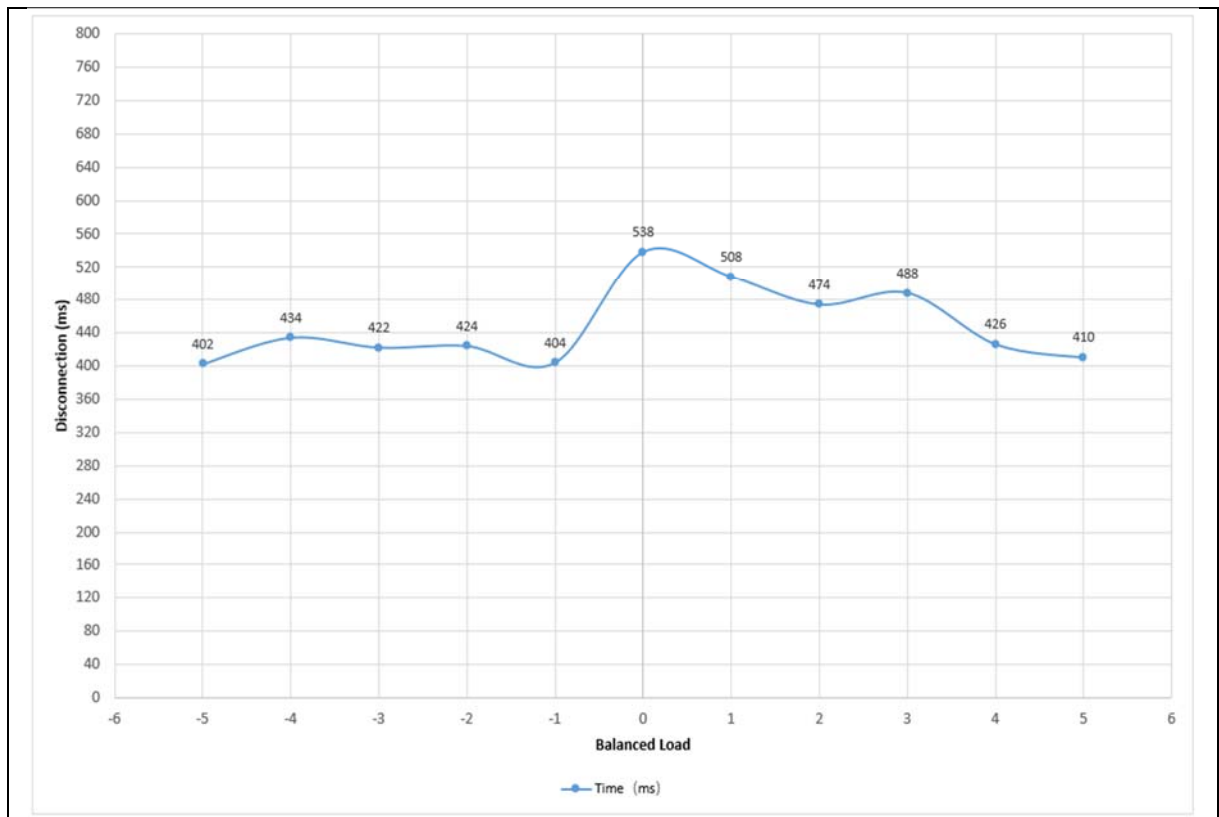

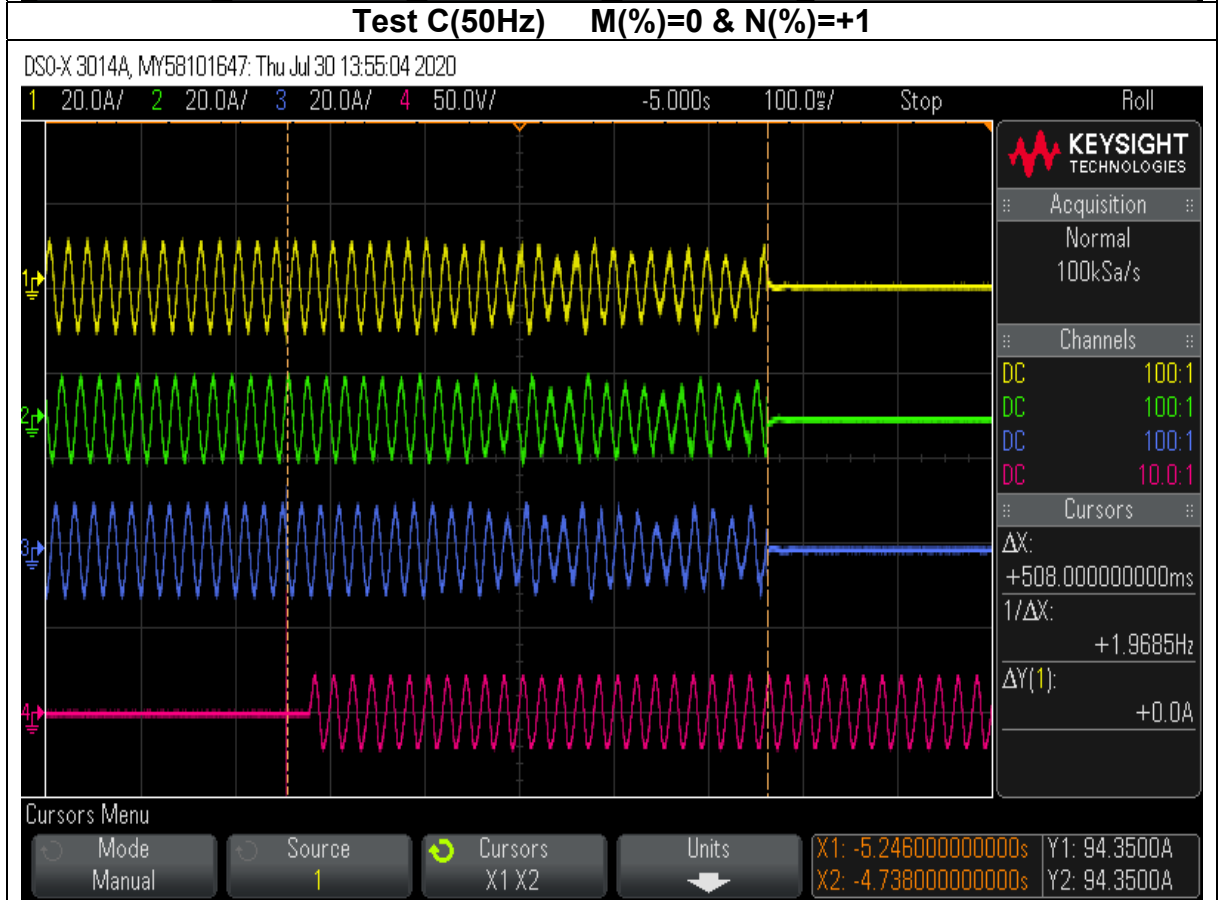
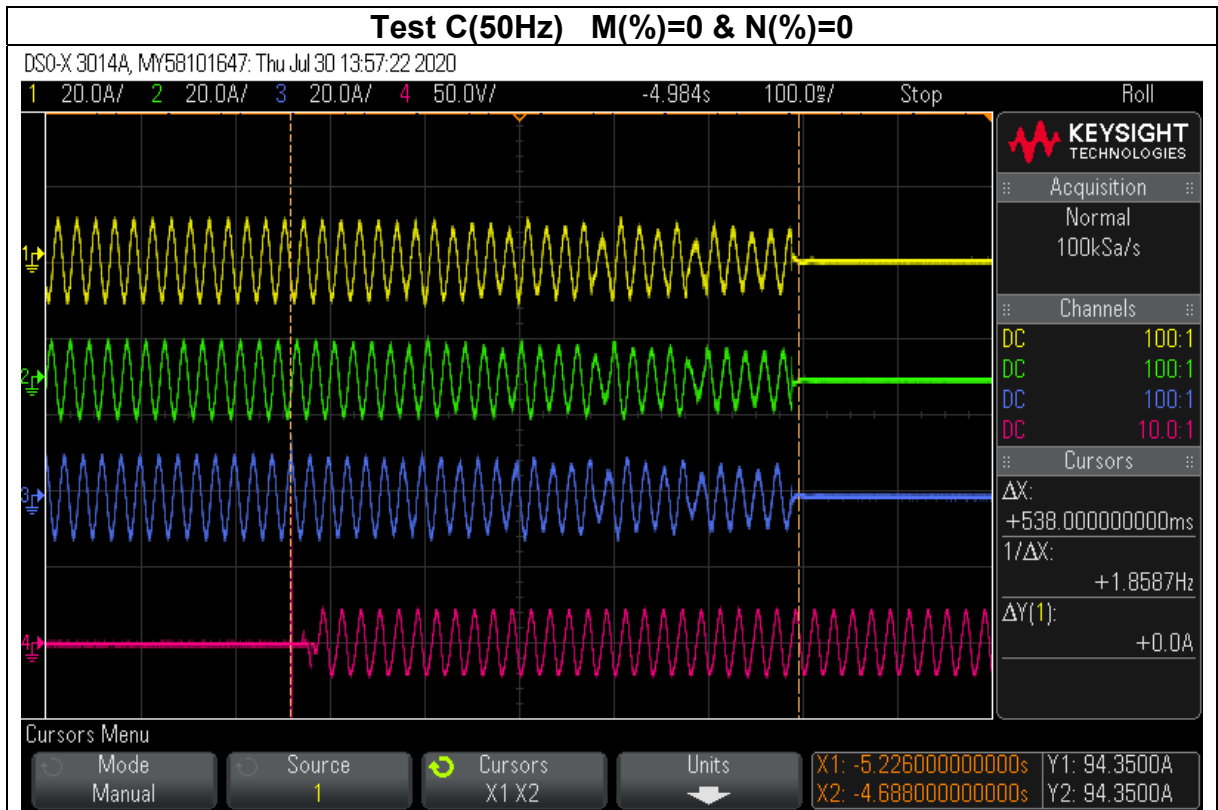

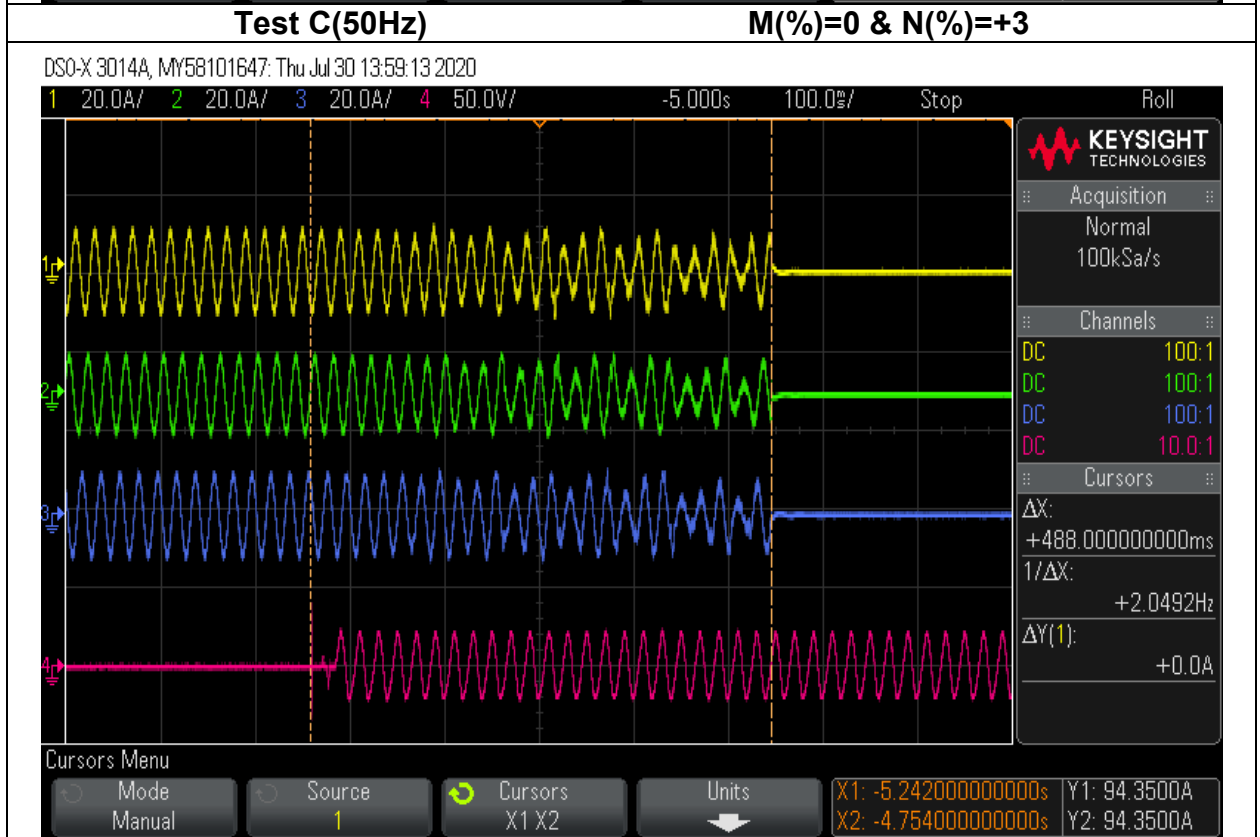
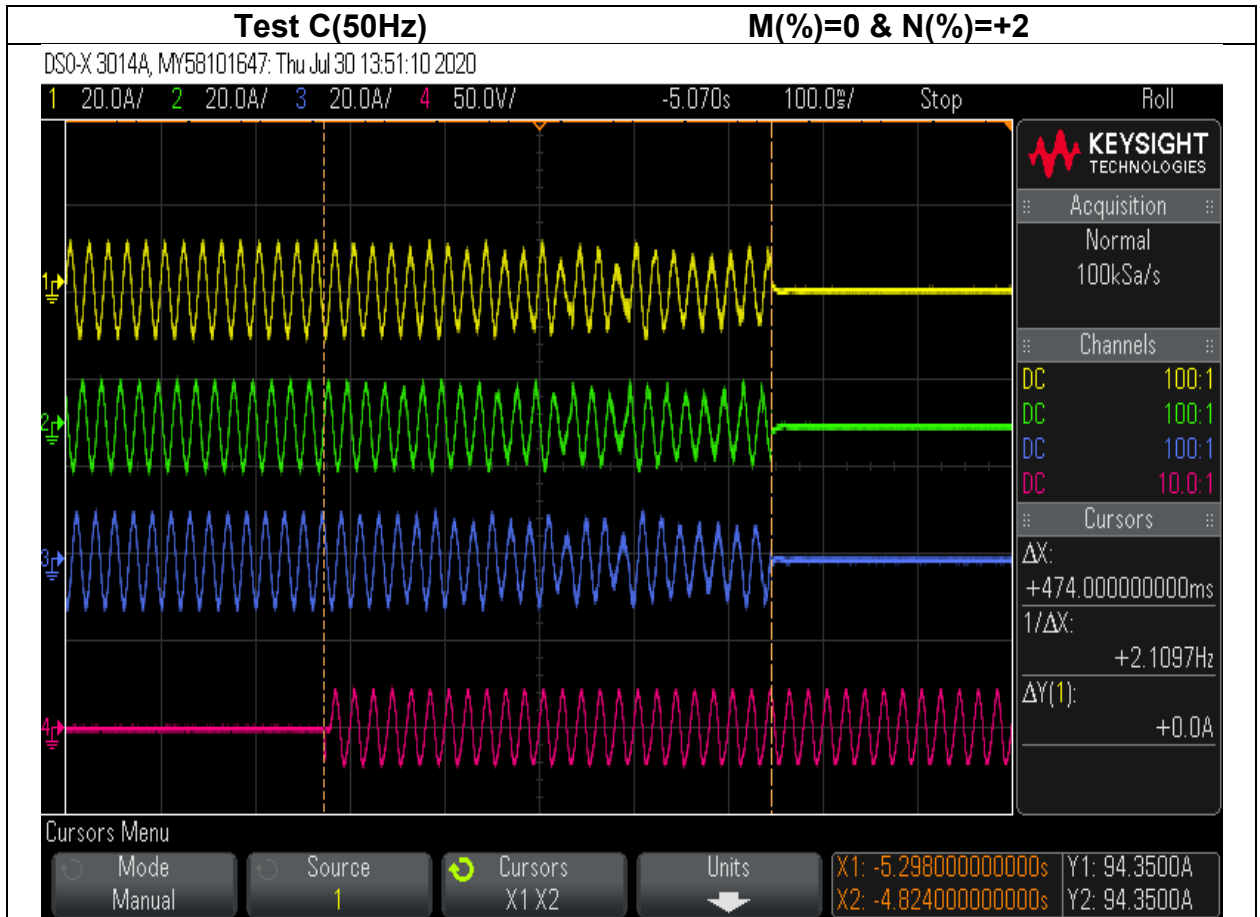

Test C(50Hz)

M(%)=0 & N(%)=+4

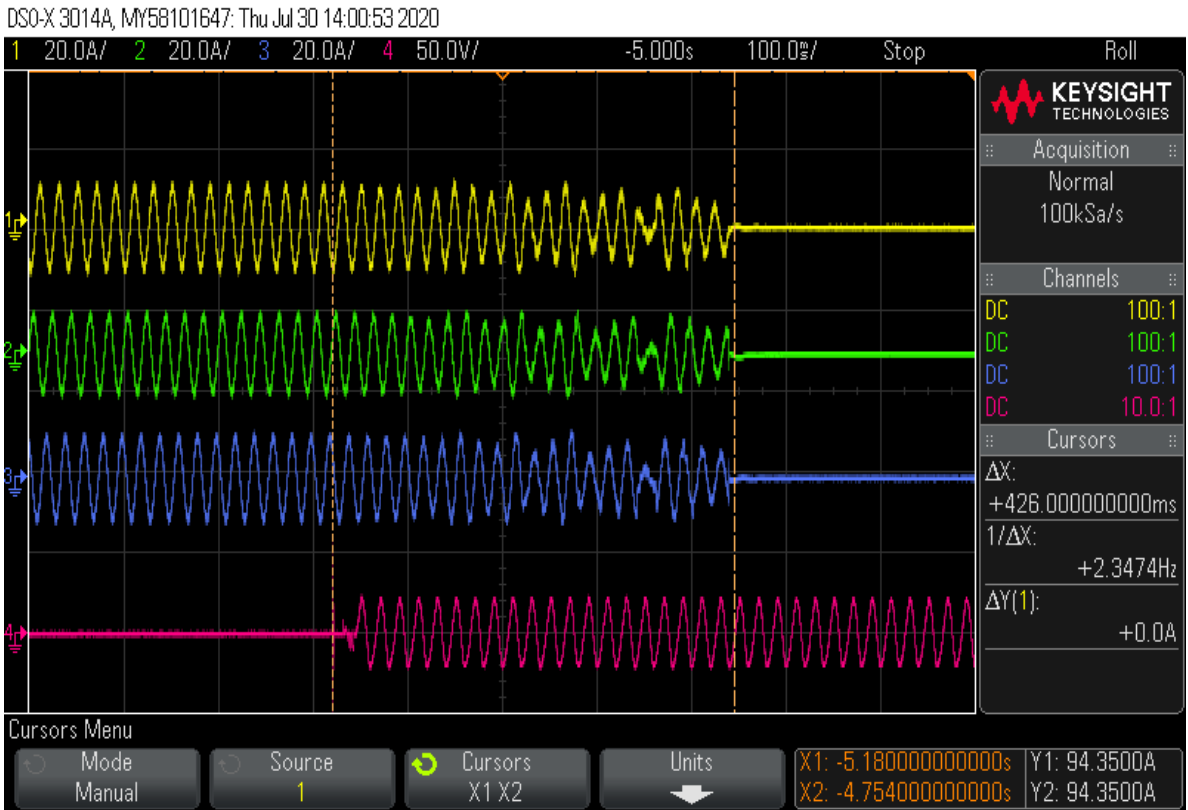

Test C(50Hz)

M(%)=0 & N(%)=+5

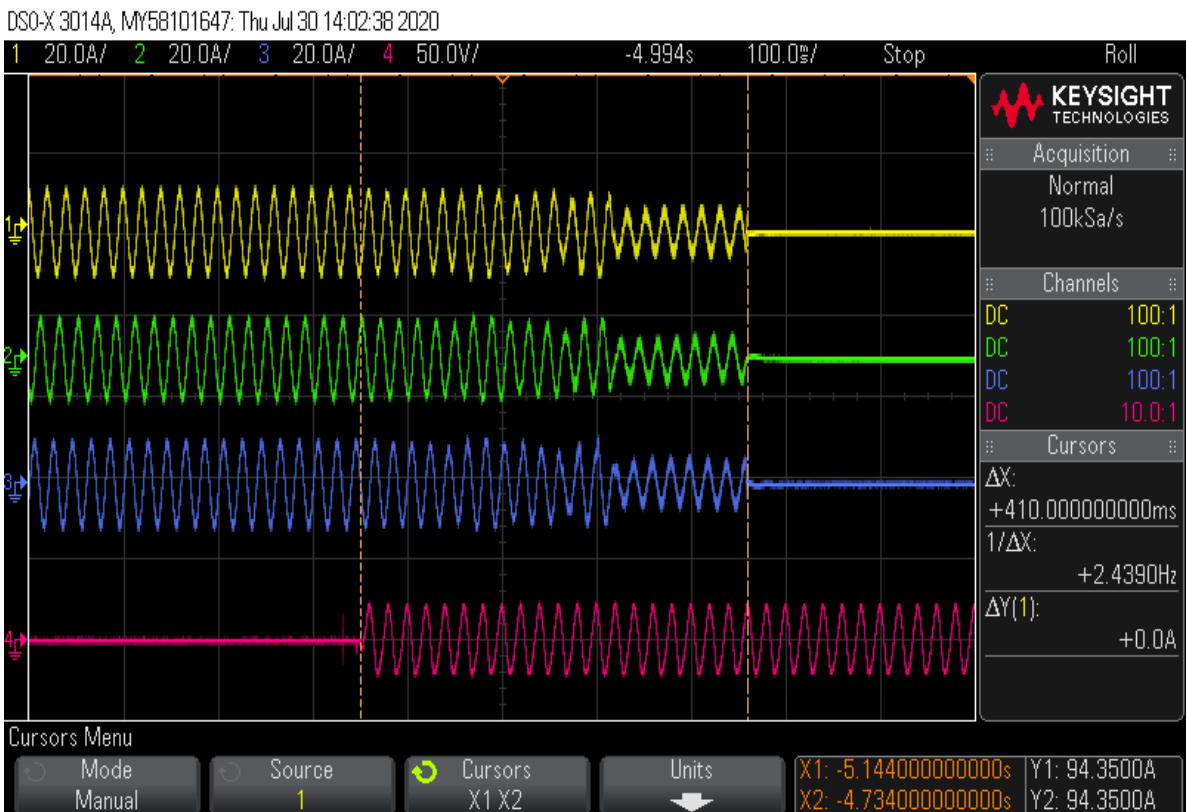

Test C(50Hz) M(%)=0 & N(%)=-1

DSO-X 3014A, MY58101647: Thu Jul 30 14:04:26 2020

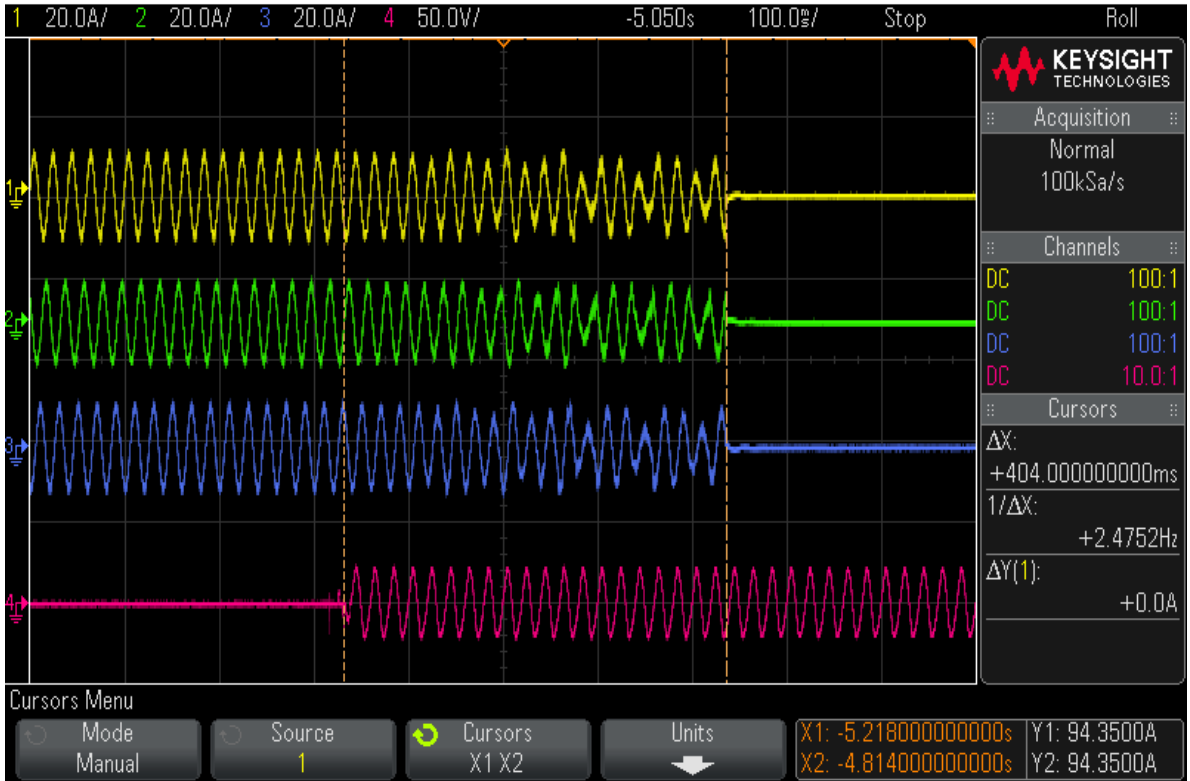

Test C(50Hz) M(%)=0 & N(%)=-2

DSO-X 3014A, MY58101647: Thu Jul 30 14:06:45 2020

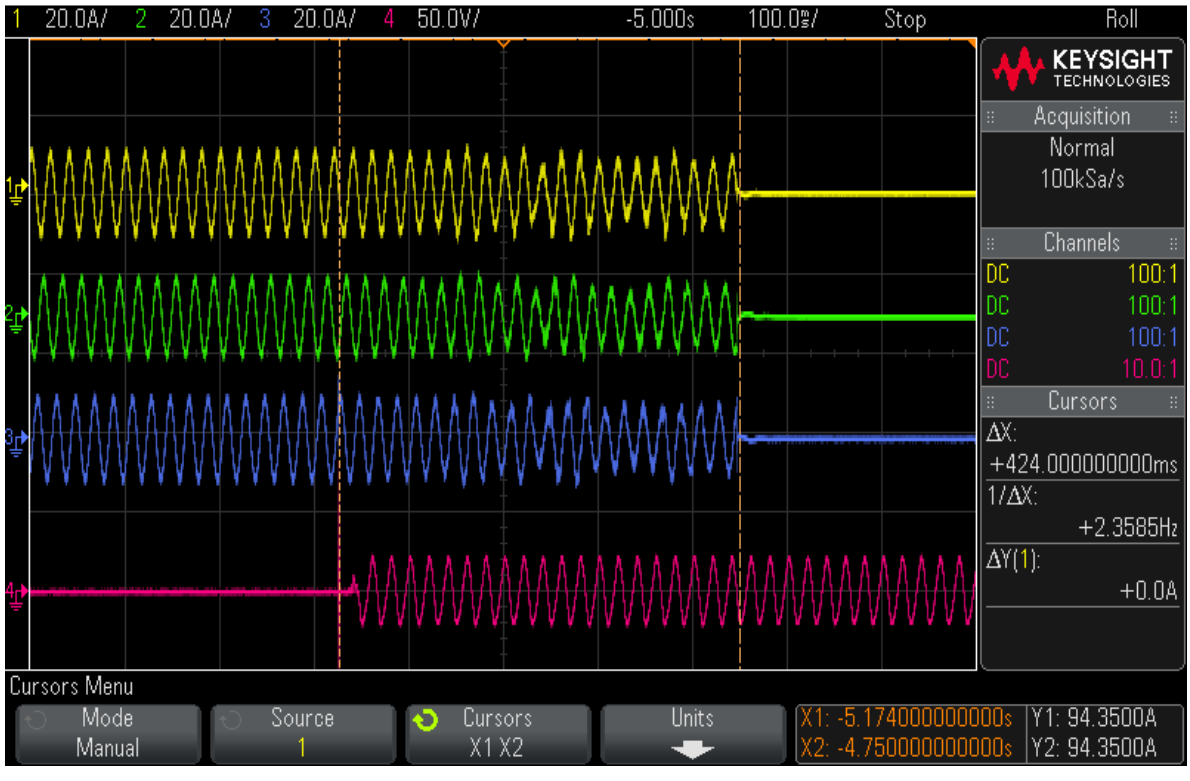

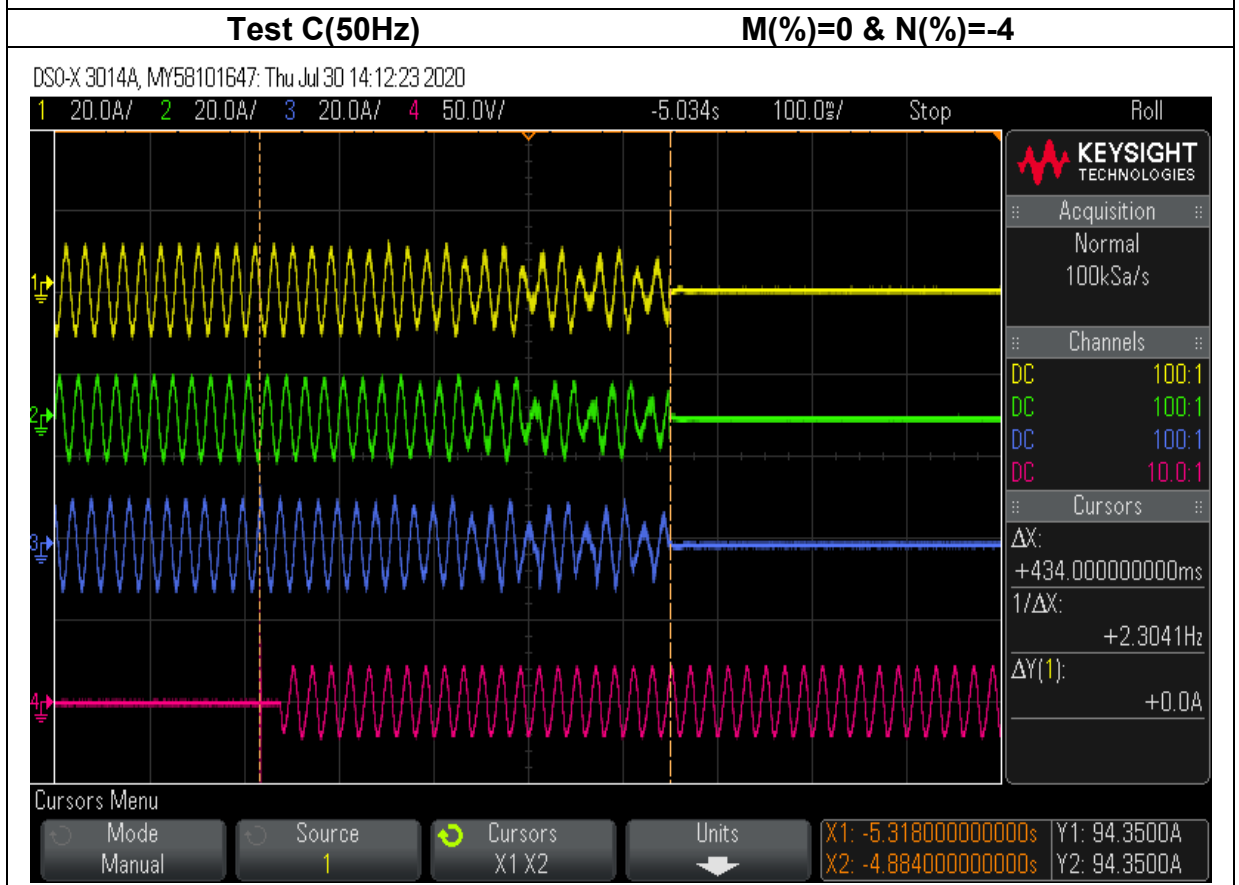
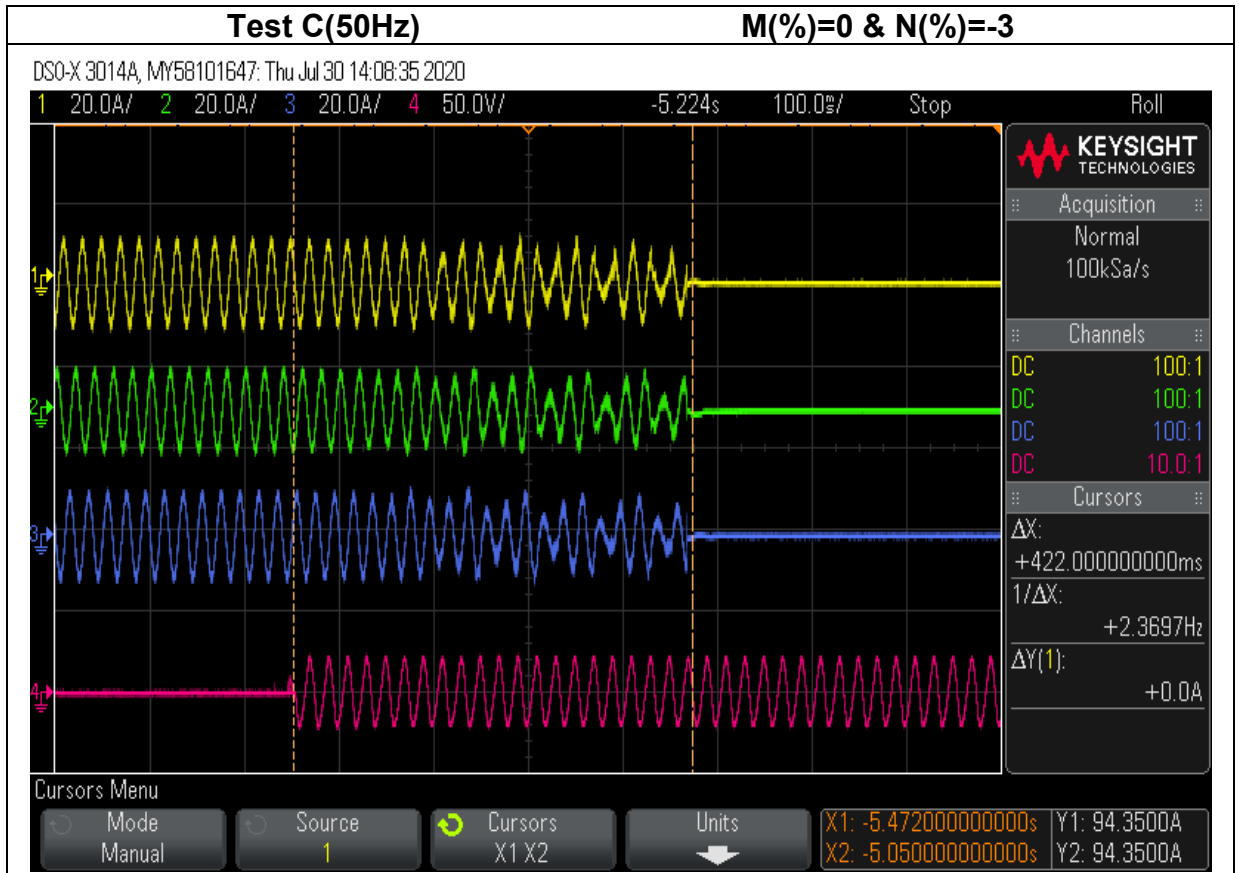

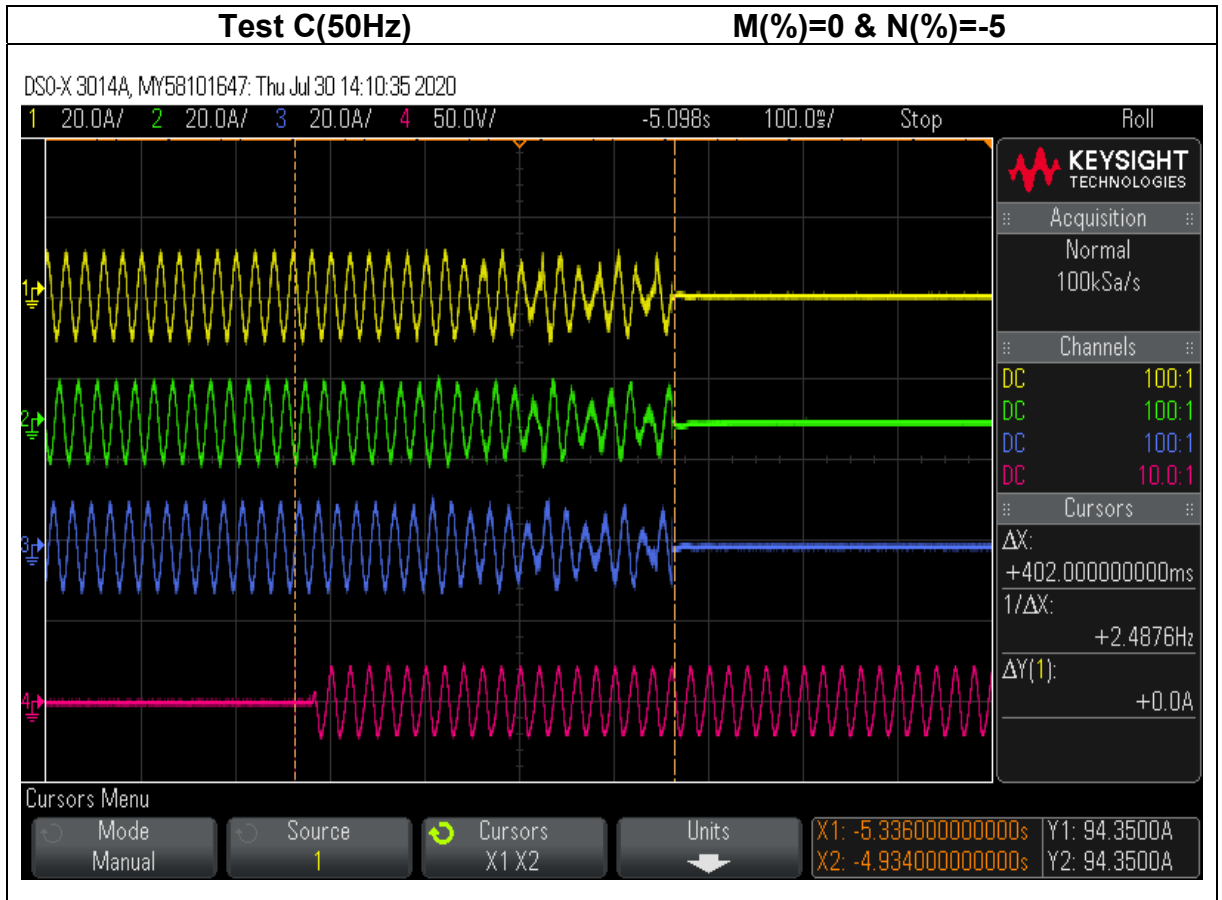

4.7 MARKING

As it can be seen in the pictures below (chapter 5 in this report) and the picture of the rating plate on 2.2 of this report the inverter accomplish all the requirements in this point of the VDE V 0126-1-1.

4.8 RESIDUAL CURRENT

This test has been done according to the standard EN 62109-2:2011, 4.8.3

The compliances with these requirements are stated in the following test reports:

-IEC 62109-2:2011: Test Report nº BL-DG2060127-B01 attachment 1 on 02 July.,2020 which issued by Shenzhen BALUN Technology Co., Ltd.

4.9 TABLE: ACTIVE POEWR OUTPUT FEED-IN AT OVERFREQUENCY

VFR 2013: Above 50,4Hz the inverter must start de-rating with 40% per Hz based on the output power at the point, when the inverter reached 50.4Hz (~51.5Hz).

VFR 2014: Above 50,6Hz the inverter must start de-rating with 40% per Hz based on the output power at the point, when the inverter reached 50.4Hz (~51.5Hz).

If the grid frequency decreases, the inverter is allowed to increase the output power in the same rate as the decreasing happened before.

String	1	U _{DC} = Un	600Vdc	U _{ac} = Un	230 Vac	P =P _n = (W)	15000 W
U _{dc} (Vdc)	F (Hz)		F (Hz)	P (W)		time	
600	a) 50Hz (± 0.01Hz)		50.00	15047.7		1 min	
600	b) 50.45Hz (± 0.05Hz)		50.45	14697.2		1 min	
600	c) 50.7Hz (± 0.1Hz)		50.70	13211.1		1 min	
600	d) 51.15Hz (± 0.05Hz)		51.15	10521.5		1 min	
600	e) 50.75Hz (± 0.10Hz)		50.70	13223.3		1 min	
600	f) 50.45Hz (± 0.05Hz)		50.45	14705.6		1 min	
600	g) 50Hz (± 0.01Hz)		50.00	15045.4		10 mins	
600	h) 51.65Hz (± 0.05Hz)		51.65	-1.6		1 min	
600	i) 50Hz (+0.06 ~ +0.1Hz)		50.10	-1.6		3 mins	
600	j) 50Hz (± 0.01Hz)		50.00	15045.9		10 mins	

Supplementary information:

See test curve as following

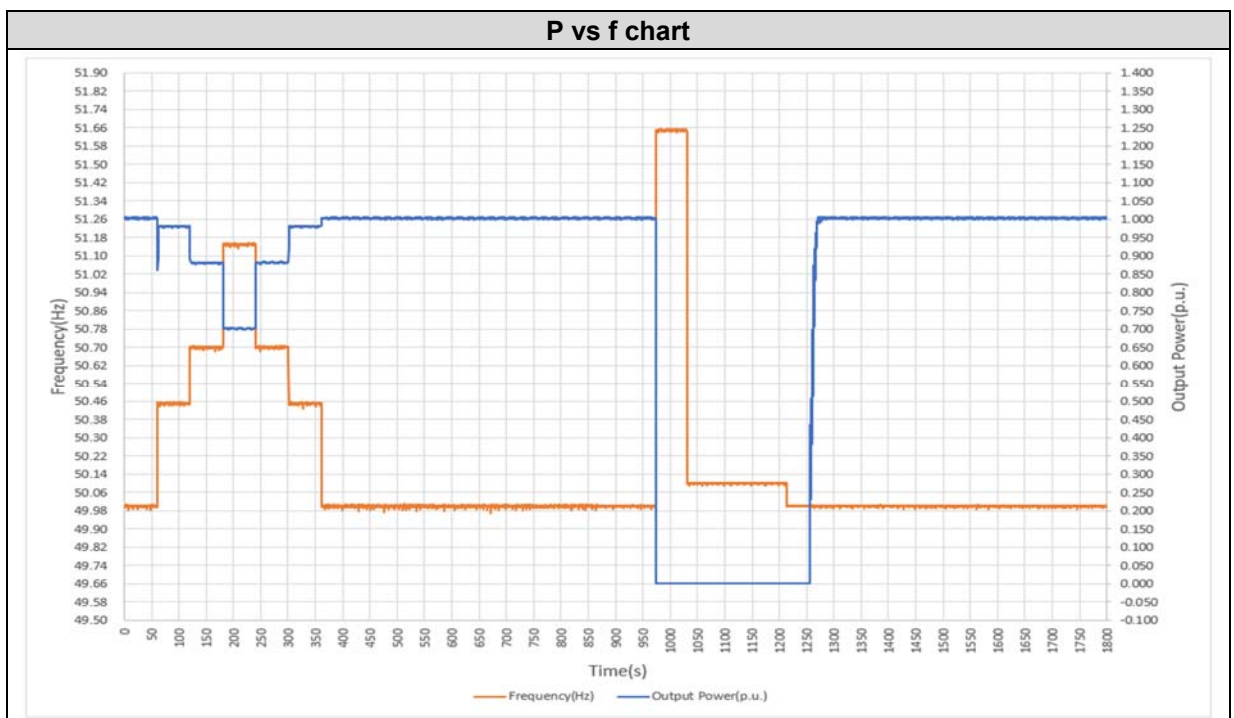

String	2	U _{DC} = U _n	600Vdc	U _{ac} = U _n	230 Vac	P =0.5 P _n = (W)	7500 W
U _{dc} (Vdc)	F (Hz)		F (Hz)	P (W)	time		
600	a) 50Hz (± 0.01Hz)		50.00	7555.8	1 min		
600	b) 50.45Hz (± 0.05Hz)		50.45	7401.9	1 min		
600	c) 50.7Hz (± 0.1Hz)		50.70	6662.2	1 min		
600	d) 51.15Hz (± 0.05Hz)		51.15	5321.5	1 min		
600	e) 50.75Hz (± 0.10Hz)		50.70	6659.3	1 min		
600	f) 50.45Hz (± 0.05Hz)		50.45	7397.4	1 min		
600	g) 50Hz (± 0.01Hz)		50.00	15047.1	10 mins		
600	h) 51.65Hz (± 0.05Hz)		51.65	-1.6	1 min		
600	i) 50Hz (+0.06 ~ +0.1Hz)		50.10	-1.5	3 mins		
600	j) 50Hz (± 0.01Hz)		50.00	15046.2	10 mins		

Supplementary information:
See test curve as following

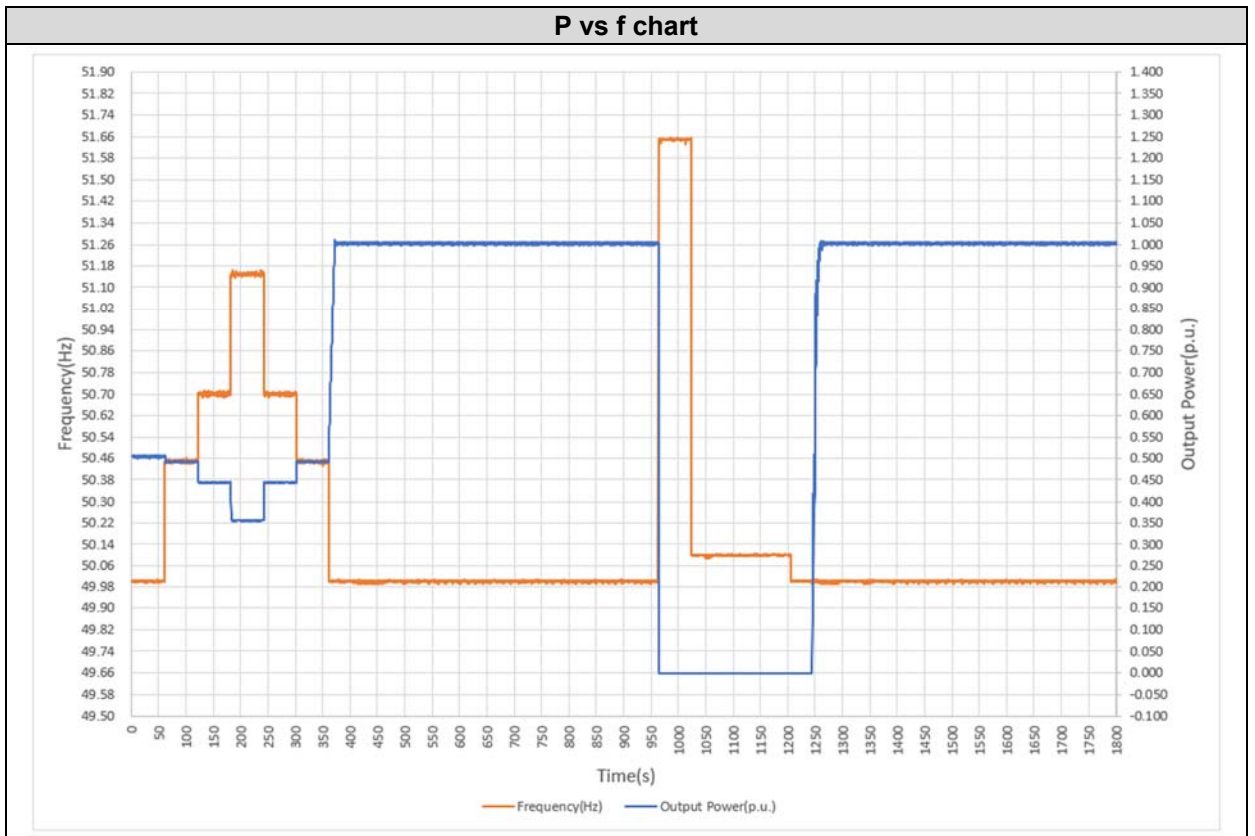

String	1	U _{DC} = U _n	600Vdc	U _{ac} = U _n	230 Vac	P = P _n = (W)	15000 W
U _{dc} (Vdc)		F (Hz)		F (Hz)		P (W)	time
600		a) 50Hz (± 0.01Hz)		50.00		15043.8	1 min
600		b) 50.65Hz (± 0.05Hz)		50.65		14724.7	1 min
600		c) 50.7Hz (± 0.1Hz)		50.70		14434.9	1 min
600		d) 51.15Hz (± 0.05Hz)		51.15		11756.9	1 min
600		e) 50.75Hz (± 0.10Hz)		50.70		14433.8	1 min
600		f) 50.65Hz (± 0.05Hz)		50.65		14732.1	1 min
600		g) 50Hz (± 0.01Hz)		50.00		15044.9	10 mins
600		h) 51.65Hz (± 0.05Hz)		51.65		-1.6	1 min
600		i) 50Hz (+0.06 ~ +0.1Hz)		50.10		-1.6	3 mins
600		j) 50Hz (± 0.01Hz)		50.00		14879.2	10 mins

Supplementary information:

See test curve as following

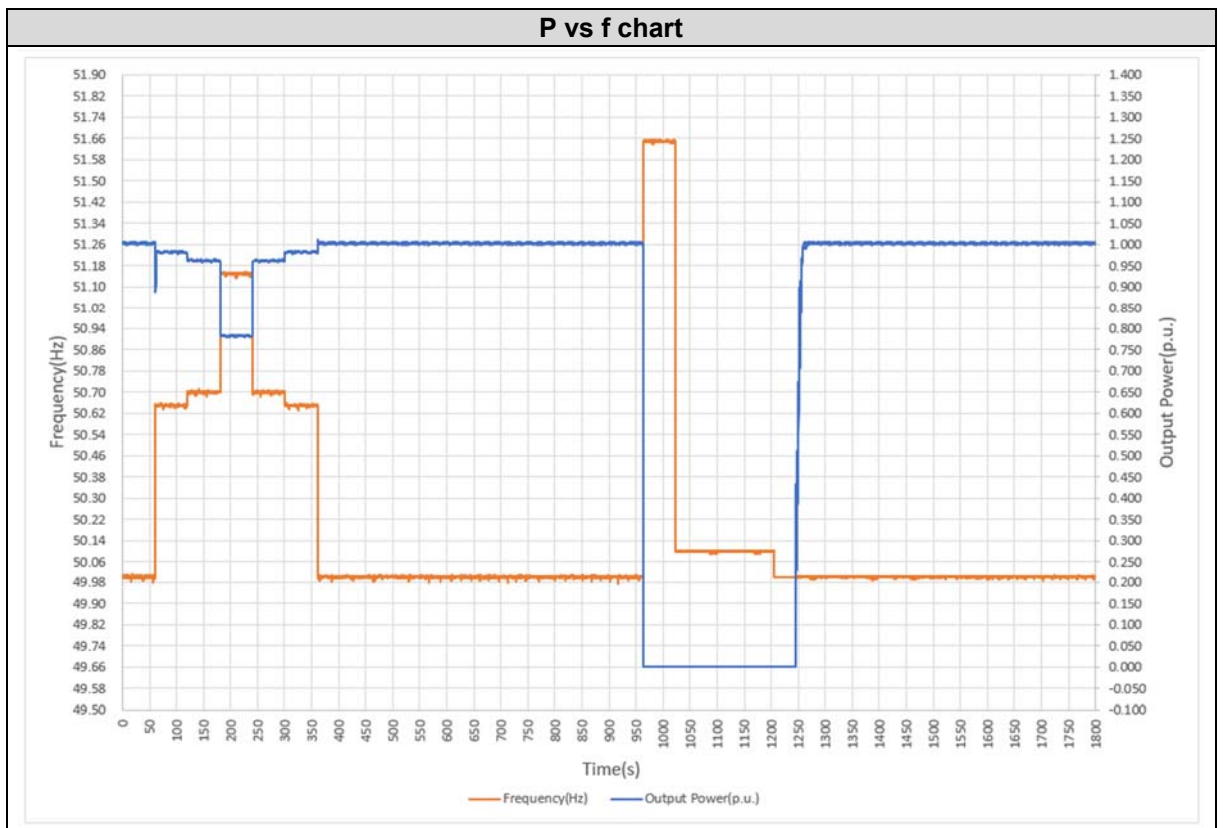

String	2	U _{DC} = U _n	600Vdc	U _{ac} = U _n	230 Vac	P = 0.5 P _n (W)	7500 W
U _{dc} (Vdc)	F (Hz)		F (Hz)	P (W)	time		
600	a) 50Hz (± 0.01Hz)		50.00	7551.9	1 min		
600	b) 50.65Hz (± 0.05Hz)		50.65	7415.1	1 min		
600	c) 50.7Hz (± 0.1Hz)		50.70	7264.7	1 min		
600	d) 51.15Hz (± 0.05Hz)		51.15	5927.5	1 min		
600	e) 50.75Hz (± 0.10Hz)		50.70	7264.2	1 min		
600	f) 50.65Hz (± 0.05Hz)		50.65	7413.2	1 min		
600	g) 50Hz (± 0.01Hz)		50.00	15046.2	10 mins		
600	h) 51.65Hz (± 0.05Hz)		51.65	-1.6	1 min		
600	i) 50Hz (+0.06 ~ +0.1Hz)		50.10	-1.5	3 mins		
600	j) 50Hz (± 0.01Hz)		50.00	15042.5	10 mins		

Supplementary information:

See test curve as following

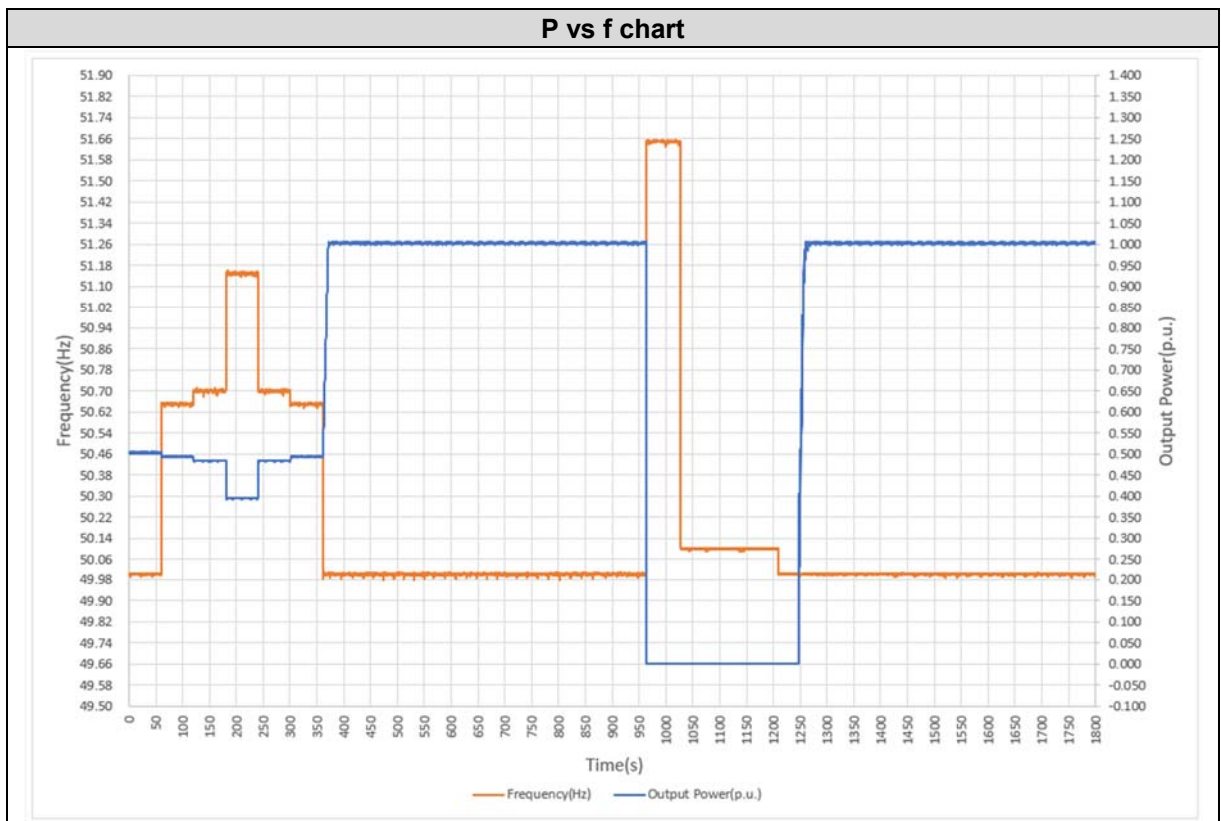

5 PICTURES

Front view



Back view



Internal View 1



Internal View 2



Front side of Power board

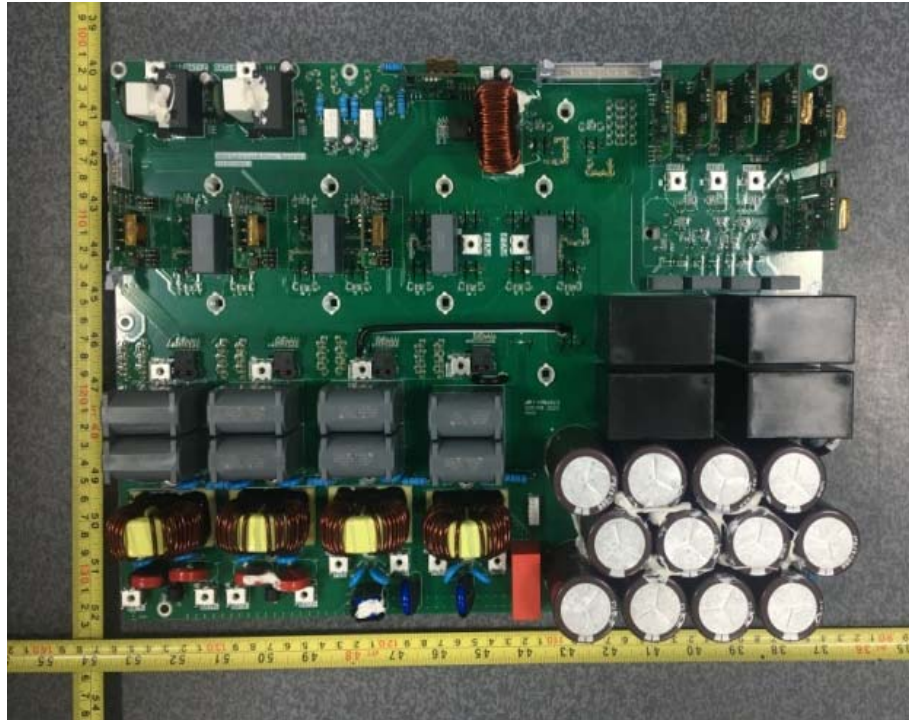

Back side of Power board

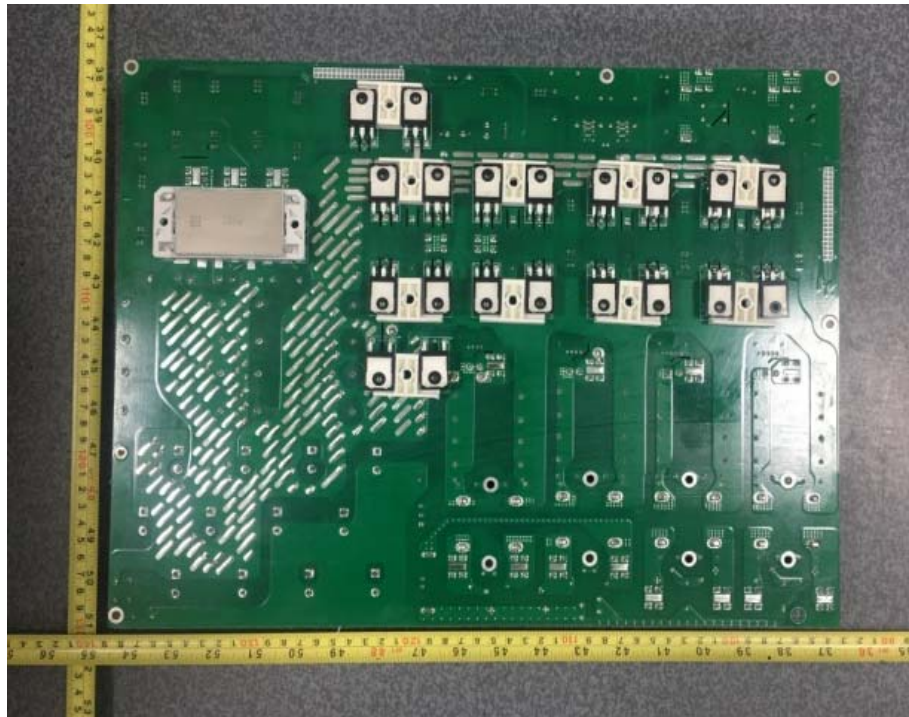

Front side of Display board

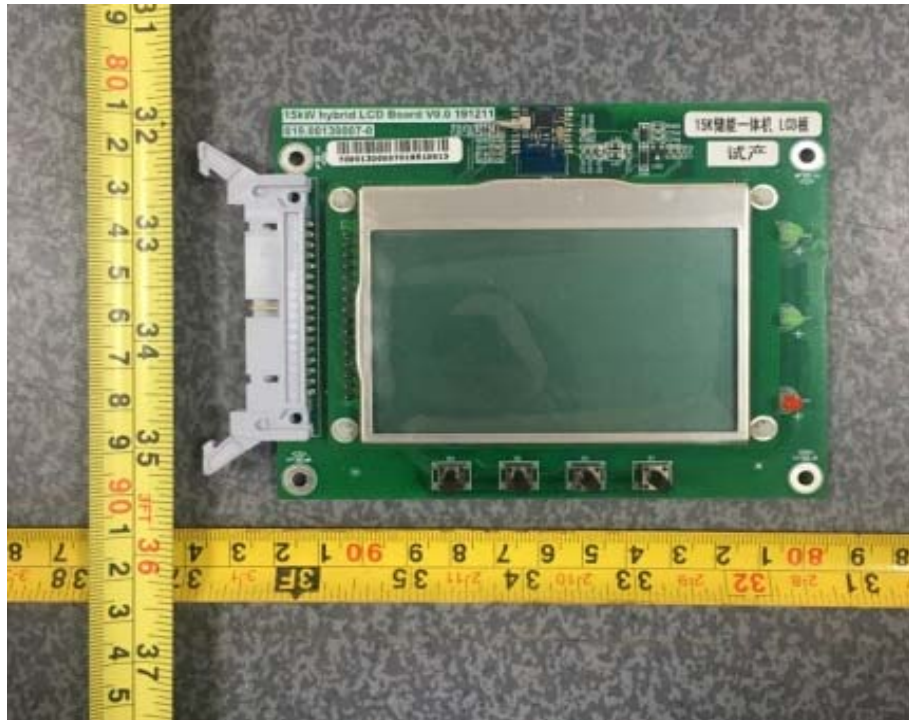

Back side of Display board

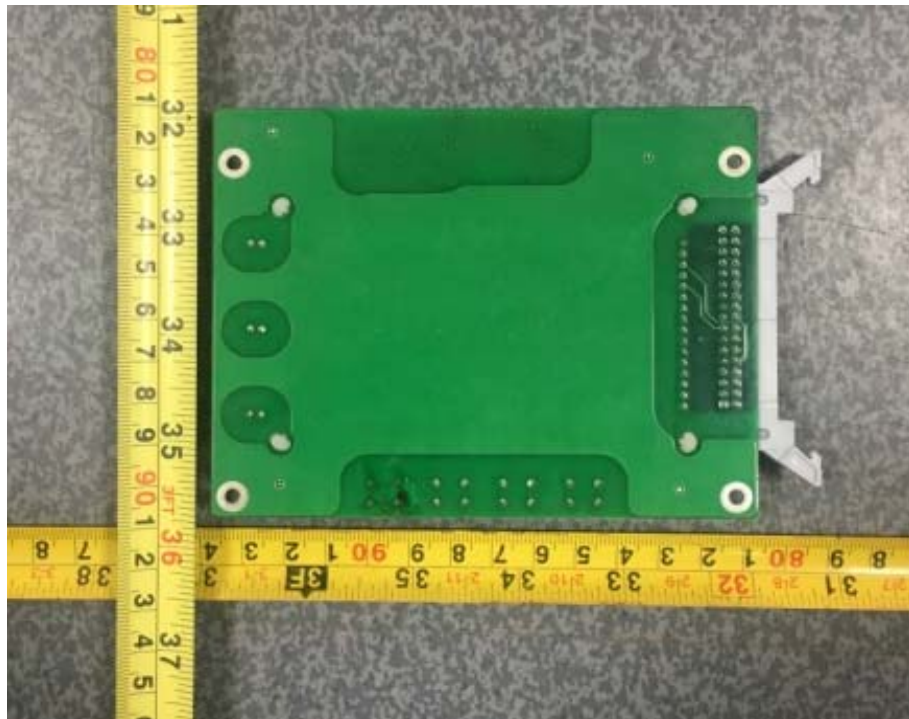

Front side of Control board

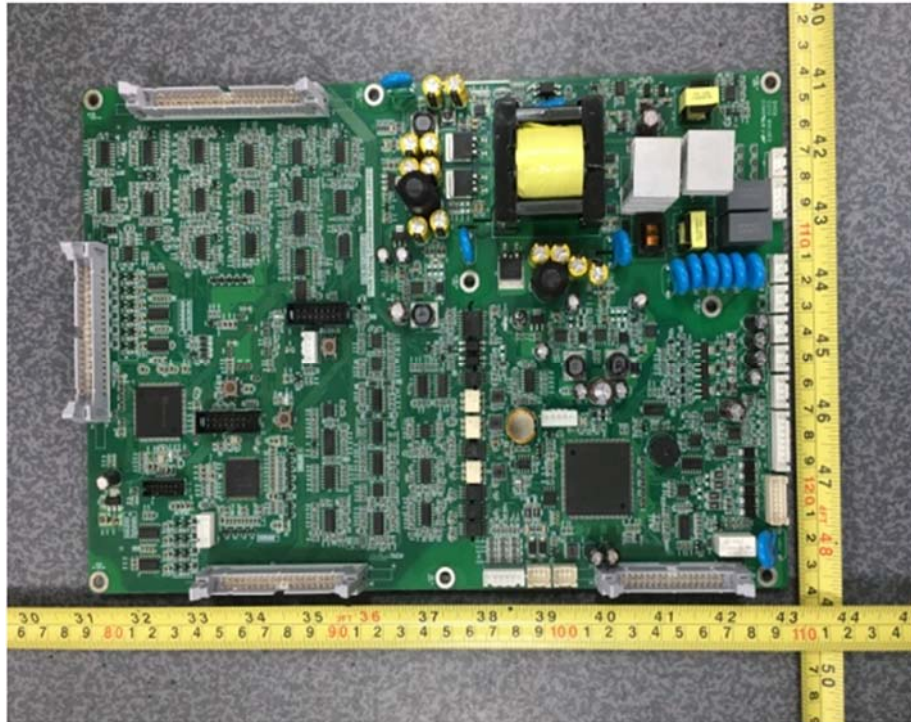

Back side of Control board



Front side of Output board front

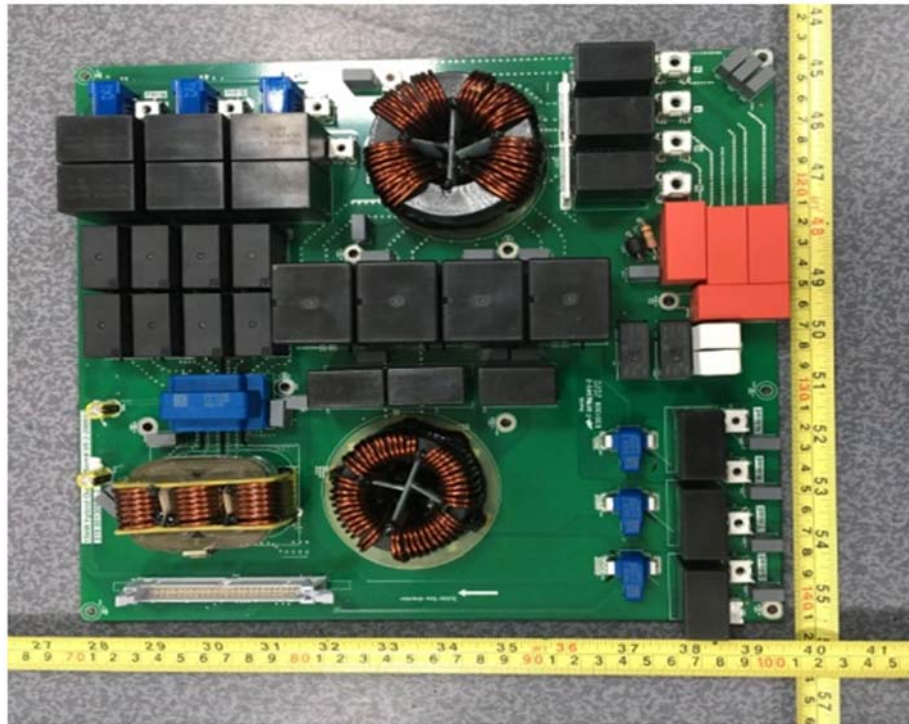

Back side of Output board front

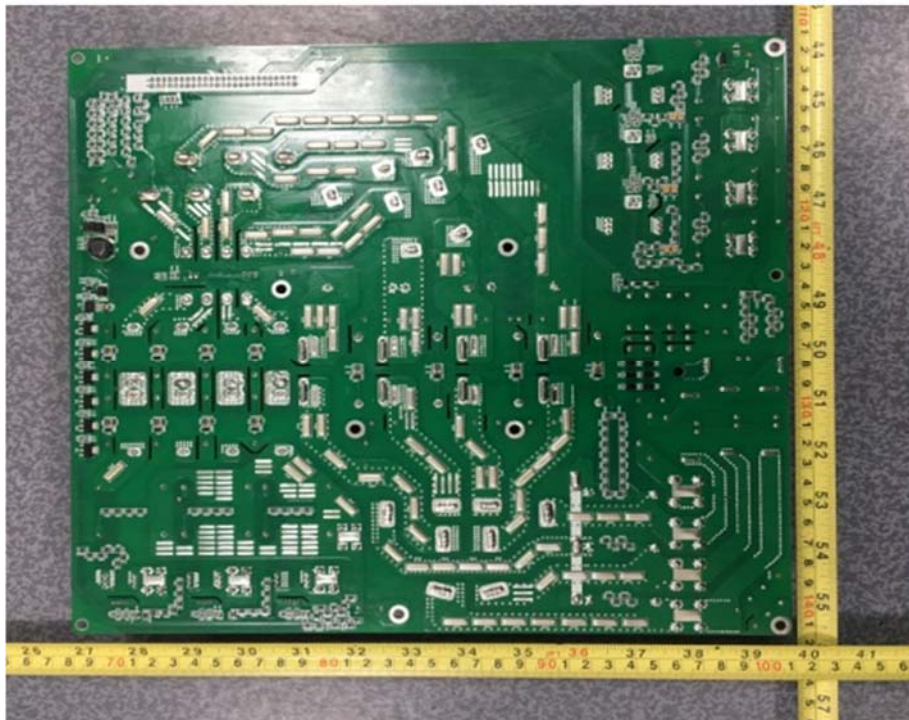

Grounding



Connection interface



Serial Number and Software Version

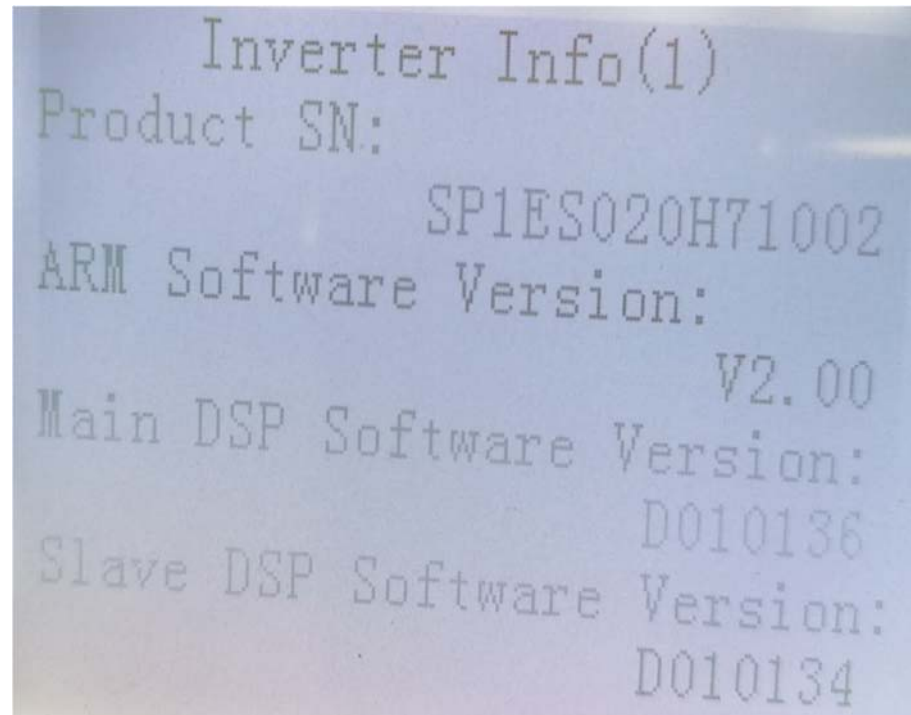

Inverter Info(1)
Product SN: SP1ES020H71002
ARM Software Version: V2.00
Main DSP Software Version: D010136
Slave DSP Software Version: D010134

6 ELECTRICAL SCHEMES

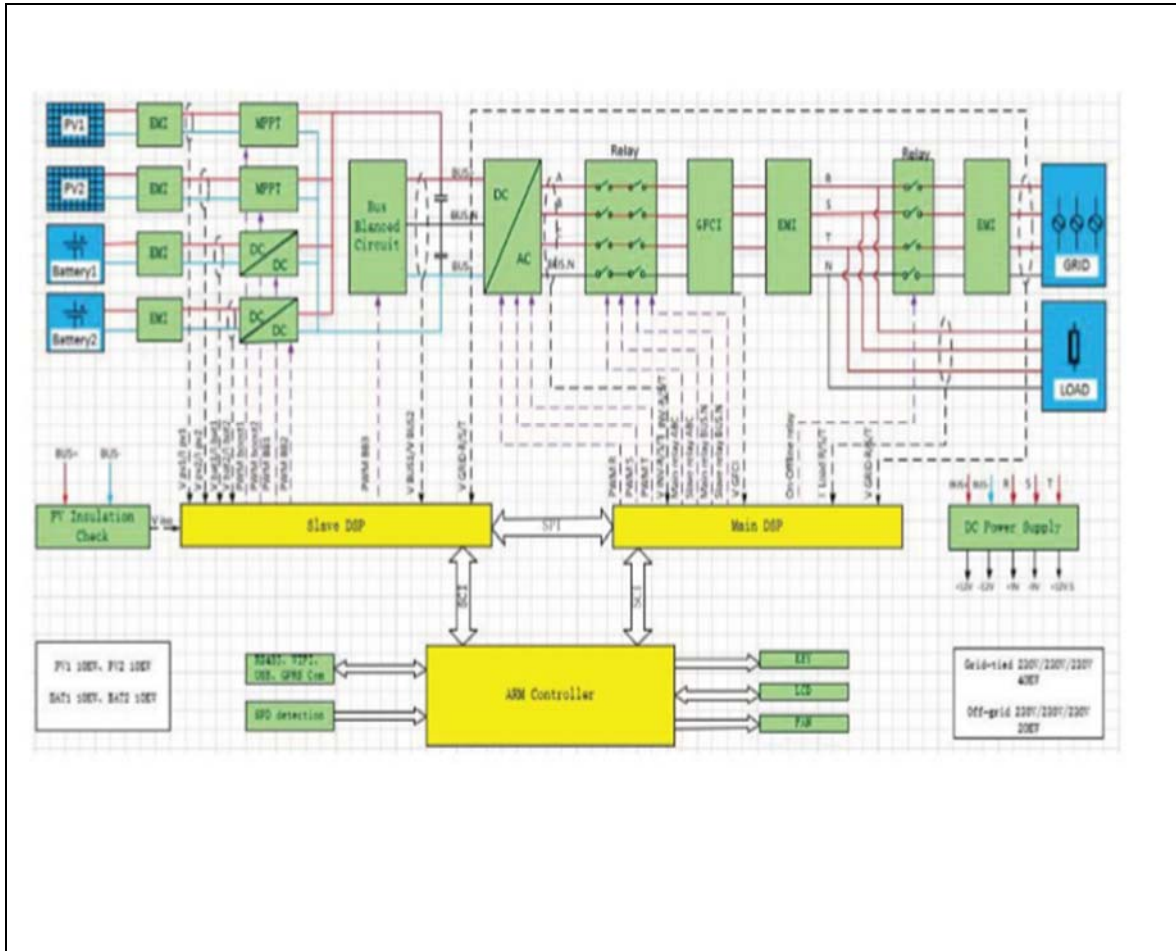

-----END OF REPORT-----